

Ericsson Dialog 4425 IP Vision

BusinessPhone Communication Platform

User Guide



EN/LZTBS 160 1345 R1A
© Ericsson Enterprise AB 2003

Table of Contents

Welcome	4
Description	6
Log On / Log Off	15
Incoming Calls	17
Outgoing Calls	20
Phone Book	26
Call List	32
During Calls	36
Call Forwarding	41
Absence Information	46
Messages	50
Security	58
Group Features	61
Other Useful Features	64
Write Text	70
Settings	72
Accessories	83
Useful Hints	86
Installation	87
Troubleshooting	96
Glossary	97
Index	99

Welcome

Welcome to the User Guide for the Dialog 4425 IP Vision in the BusinessPhone Communication Platform from Ericsson. The BusinessPhone Communication Platform consists of BusinessPhone 50, BusinessPhone 128i and BusinessPhone 250.

The features described in this User Guide are related to version 5.1 or higher of the BusinessPhone Communication Platform. Some might not work in earlier versions of the system and/or might be protected by a hardware dongle that has to be bought separately.

The User Guide describes the facilities of the BusinessPhone Communication Platform and the Ericsson Dialog 4425 IP Vision with a default programming. There may be some differences in the way your phone is programmed. Please consult your system administrator if you need further information.

The latest version of this User Guide can also be downloaded from: <http://www.ericsson.com/enterprise/>

Note: *Dialog 4425 IP Vision is an IP telephone conforming to the H.323 standard, i.e. it can only be used with a local area network (LAN) that supports this type of telephone.*

The Dialog 4425 IP Vision supports the Dynamic Host Configuration Protocol (DHCP) for determination of IP addresses. If DHCP is not supported by the LAN, please contact your system administrator.

Copyright

All rights reserved. No parts of this publication may be reproduced, stored in retrieval systems, or transmitted in any form or by any means, electronic, mechanical, photocopying, recording or otherwise, without prior written permission of the publisher except in accordance with the following terms.

If this publication is made available on Ericsson media, Ericsson gives its consent to downloading and printing copies of the content provided in this file only for private use and not for redistribution. No parts of this publication may be subject to alteration, modification or commercial use. Ericsson will not be liable for any damages arising from use of an illegal modified or altered publication.

Warranty

ERICSSON MAKES NO WARRANTY OF ANY KIND WITH REGARD TO THIS MATERIAL, INCLUDING, BUT NOT LIMITED TO, THE IMPLIED WARRANTIES OF MERCHANTABILITY AND FITNESS FOR A PARTICULAR PURPOSE. Ericsson shall not be liable for errors contained herein nor for incidental or consequential damages in connection with the furnishing, performance or use of this material.

Declaration of Conformity

Hereby, Ericsson Enterprise AB, S-131 89 Stockholm, declares that this telephone is in conformity with the essential requirements and other relevant provisions of the R&TTE directive 1999/5/EC.

Details to be found at:

<http://www.ericsson.com/sdoc>

Description

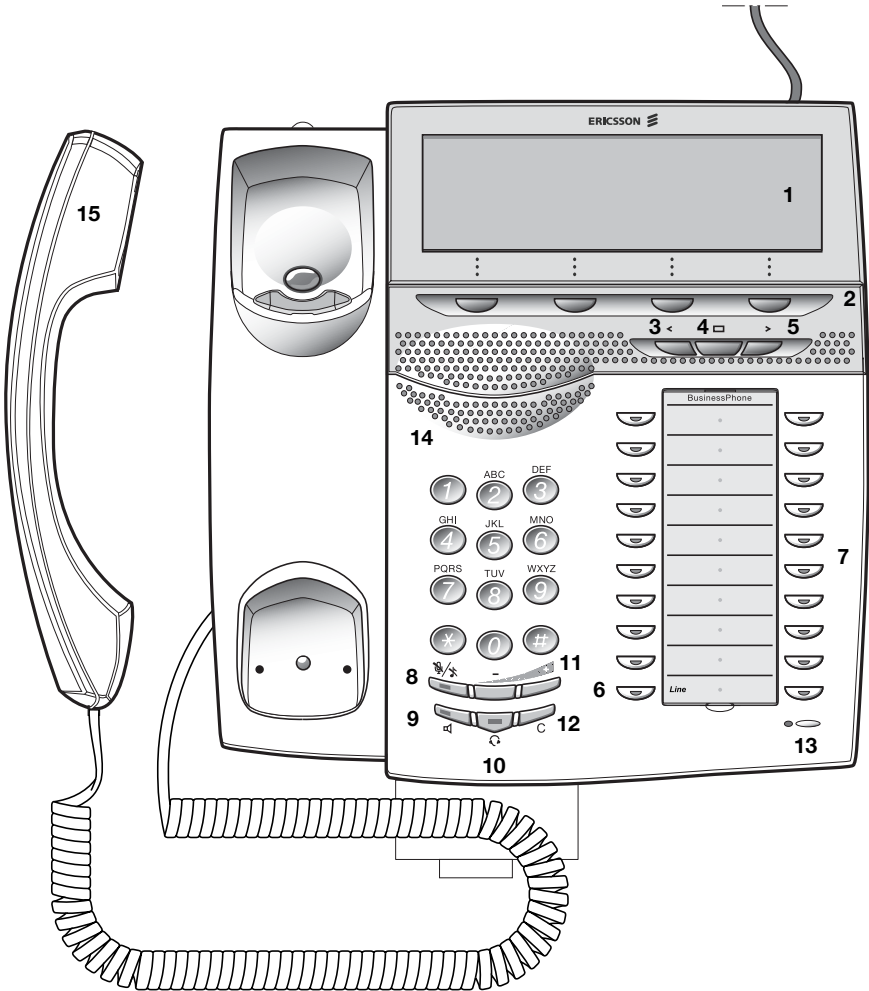

- 1 Graphical display**
320x80 pixels. Four angle tilt. See section “[Display info](#)” on page 9.
- 2 Menu function keys**
The functions depend on the traffic state. When you are requested to (**see display**), press the required key to access the function.
- 3 Left Navigation key**
To navigate one position to the left.
- 4 Home Navigation key**
To return to the home position
- 5 Right Navigation key**
To navigate one position to the right.
- 6 Line**
To initiate or receive calls.
- 7 Programmable keys**
Storing numbers, program functions. Can be programmed as speed dial keys, function keys, etc. See section “[Program a function](#)” on page 73.
- 8 Mute**
To switch the microphone on or off during a call. See sections “[During Calls](#)” on page 36 and “[Silent Ringing](#)” on page 19.
- 9 Loudspeaker on/off**
To switch the loudspeaker on or off to enable handsfree connections. See section “[During Calls](#)” on page 36.
- 10 Headset**
See section “[Headset](#)” on page 83.
- 11 Volume control**
 - a. To adjust the ringing volume and the incoming speech volume for the handset and loudspeaker.
 - b. Space/backspace in writing mode.
- 12 Clear**
To disconnect calls or to clear the display in programming.
- 13 Microphone**
- 14 Loudspeaker**
- 15 Handset with hearing aid function**

Please note: *The handset may attract and retain small metal objects in the earcap region.*

Lamp indications

The key lamps on your telephone indicate with different signals the traffic state of the ongoing call or function.



Extinguished lamp

The function is not active.



Steady light

The function is active.



Slowly flashing lamp

The line (or function) is put on hold.



Rapidly flashing lamp

An incoming call.



Light with short breaks

Ongoing call.

Display info

The graphical display assists your actions on the phone with step-by-step instructions.

The fields in the display consists of the following information:

The top area is the tab field, which is used to indicate the tab the user has selected by using the navigation keys.

The middle area is divided into several fields, showing the time and date, the user name and the extension number, icons and a level bar, the traffic state, the calling or called name and number, and the parked name and number. The lower line presents lead texts for the menu keys.

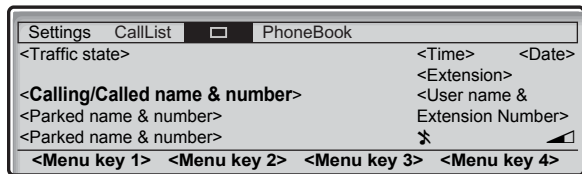

When your phone is idle and there is no missed incoming call, the display shows the date and time, the user name and the extension number.

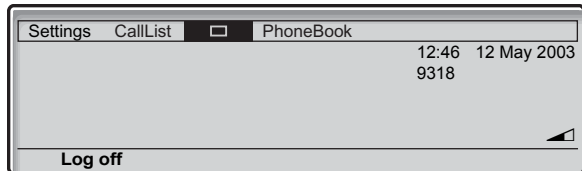

When initiating an outgoing call, the second row will show the traffic state information and the dialed number.

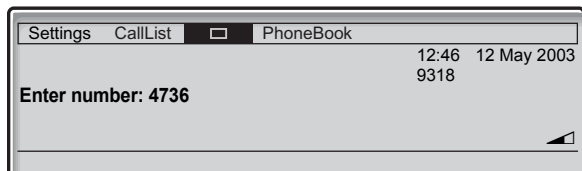

When the dialed number is free, the display will show the traffic status, and the name and number of the called party. When the dialed number is busy, the display will show Busy instead of Calling in the first row.

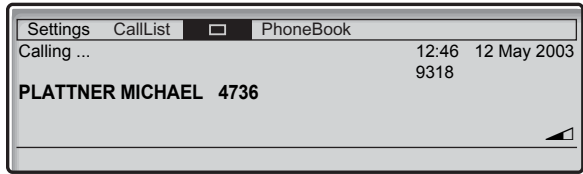

During an internal incoming call, the display will show the traffic state, and the caller's name and directory number.

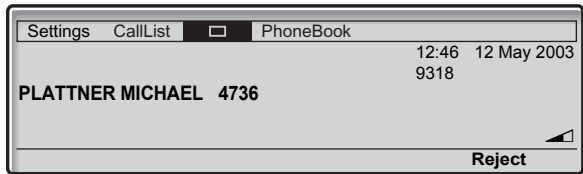

If you make an inquiry, the display will show the inquiry call connection in the second row. Additionally, you can see the name and number of the last call you have put on hold in the lower row of the middle area of the display.

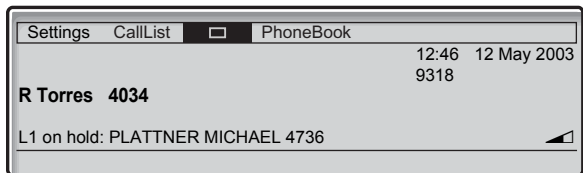

Display icons



Home

Home position (idle mode).



Level bar

Indicates the ringing volume.



Silent Ringing

Silent Ringing has been activated. The ring signal is switched off.



Incoming call

Indicates an incoming call.



Outgoing call

Indicates an outgoing call.



Scroll bar

If a list, for example your telephone directory or a list with several menu options, is too long to be shown in the display, a scroll bar appears as an indicator.



Checked radio button

If a radio button is checked, the respective option has been selected.



Unchecked radio button

This means that the respective option is not selected.

Menu Structure

The available IP specific telephone and network functions can be accessed via the menus. This section shows the structure for each of the menus that can be selected from the Home menu.

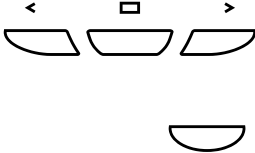

Use the navigation keys to go to the Settings, Call List, or PhoneBook menu.

When you have selected a menu with the navigation keys:

Press a menu function key to select an option (see display).

Note: Since the Dialog 4425 IP Vision can be used in different networks, some functions might not be supported by your system.

Top menu

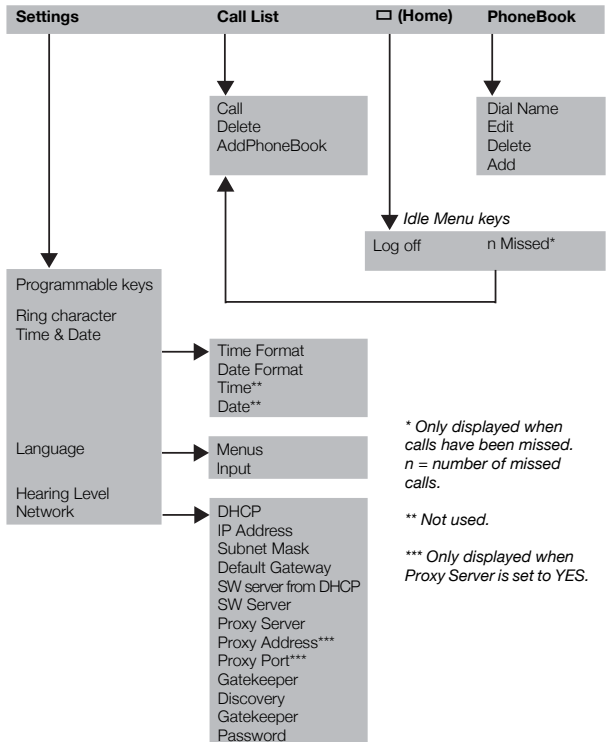

* Only displayed when calls have been missed. n = number of missed calls.

** Not used.

*** Only displayed when Proxy Server is set to YES.

Tones

Tones are audible in the handset.

Dial tone

(System ready to accept digits)



Special dial tone

(System ready to accept digits, active diversion on telephone)



Ringing tone

(Ringing signal to called party)



Special ringing tone



Busy tone

(Called party is busy)



Number unobtainable tone

(Called number not accessible or vacant)



Call Waiting tone



Blocking tone

(Call cannot be executed due to congestion or called party blocked)

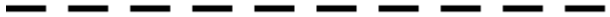

Verification tone

(Verification that ordered function is accessed)

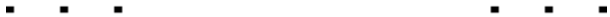

Intrusion tone

(Sent to all parties during Intrusion)



Signals

Ringing signals are emitted from the phone.

Internal ringing signal



- repeated after 4 s

External ringing signal



- repeated after 4 s

Automatic Callback signal



Note: *The tones and ringing signals in this guide refer to the standard system but may vary between countries.*

Log On / Log Off

To log on

After your phone has been installed and powered up, the following log on screen will be displayed:

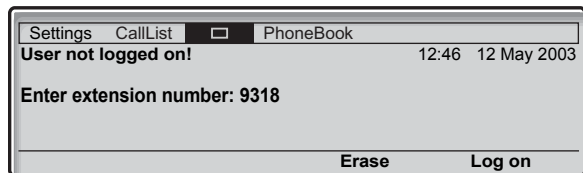

Note: *The Dialog 4425 IP Vision is powered by the LAN connection or optionally via an external 24 volt AC/AC adapter. If the telephone is powered by the LAN, no additional power adapter is needed.*

The LAN (or the external power adapter) must be connected to the telephone before use. If the power connection fails, your IP phone will not work.



Log on

Enter your extension number and press (see display).

If you have logged on using this telephone before, the extension number used at the previous log on is displayed. In this case, you do not have to enter your extension number; just press Log on to go ahead.

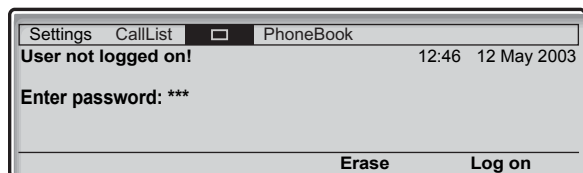

Log on

Enter your Password and press (see display).

If you do not know your Password or extension number or a screen other than the log on screen is displayed, contact your system administrator.

Note: If you do not enter a Password during the log on procedure, you cannot access the Enter Password option in the Settings menu. See also section [“Password menu presentation”](#) on page 81.

When log on is complete, this screen will be displayed:

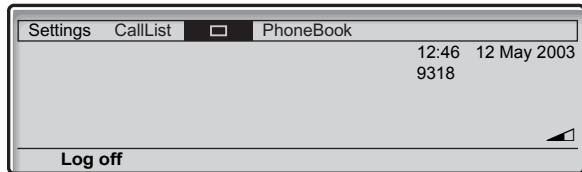

Note: This screen represents the display when the phone is ready to place, receive calls, etc. (normal state). Sometimes a new application software may be available. For more information, see section [“Software updates”](#) on page 88.

To log on with a different extension number

If you have already logged on using this telephone before, the extension number used at the previous log on is displayed.

To delete the displayed number:



Log on

Enter your extension number and press (see display).



Log on

Enter your Password and press (see display).

Erase

Press (see display).

To log off

Log off

Press to log off (see display).

You are asked to confirm the process.

Yes

Press to confirm.

The log on screen is displayed.

Incoming Calls

A ringing signal, a flashing Line key lamp and the display indicate an incoming call.

Answer calls

When you receive an incoming call, the display shows:

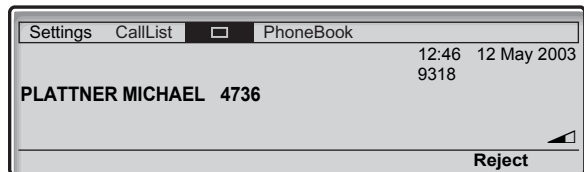

Lift the handset to accept the call.

Or:

Reject

Press to dismiss the call (see display).

Note: *The rejected call is added to the Call List, see section "Call List" on page 32.*

Handsfree

Line 

Press without lifting the handset.

Or:



Press without lifting the handset.

You are connected via the loudspeaker and microphone.



Press to terminate a handsfree call.

On another extension

You can answer a call to another extension from any phone in your office.



Call the ringing extension.

You receive busy tone.

6

Press.

Answer a second call

You are on the phone, when a muted ringing signal and a Line key flashes to indicate a new incoming call. You have two options.

Option 1:

Finish the ongoing call:



Press.

The ongoing call is terminated and the new call will be signalled on your phone.



Press the flashing Line key.

Option 2:

Ask your conversation partner to wait:



Press.



Replace the handset.

The waiting call will be signalled on your phone.



Lift the handset to receive the new call.

After finishing the new call:



Replace the handset.

Your first call will be signalled on your phone.



Lift the handset to receive the first call again.

Silent Ringing

This function is useful if you do not want to be disturbed by the ringing of the telephone. Incoming calls will only be indicated by the display and the flashing Line key(s).



In idle mode:

Press to mute the ringer for incoming calls.

Now the key lamp shows a steady light and the level bar is changed to an over-stroke note icon, see section “[Display icons](#)” on page 11.

The Silent Ringing function will be active until you use your telephone again, for example by lifting the handset or pressing a key.

Outgoing Calls

Sometimes you make a call but the person is not available. These functions will help you in your attempts to establish contact with the called party.

Make calls

How to make internal and external calls.

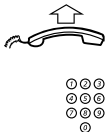

Lift the handset and dial either:

An extension number to make an internal call.

Or:



The digit(s) for external call access and the external number.

Note: Which digit to press for external call access, depends on the configuration of the system.

The display shows the entered number, for example:

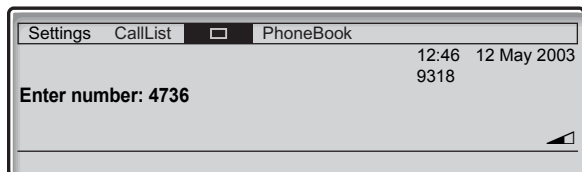

After entering the number, the number is dialled immediately.

When the dialled number is free and ringing, the display shows:

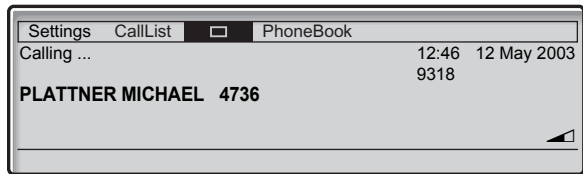

When the connection has been established, the display shows the other party's name and number (if supported by the network).

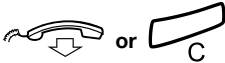

Press to end the call.

Note: You can make your calls faster, using *Common Abbreviated Numbers* and by programming your own *Abbreviated Numbers*.

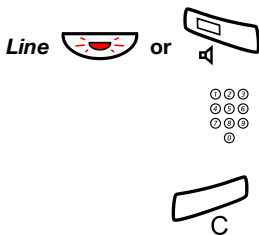

Handsfree

Press without lifting the handset.

Dial the internal or external number.

When the call is established, you will be connected to the other party via the loudspeaker and microphone.

Press to terminate a handsfree call.

Note: To learn more about other ways to make a call, see sections "[Abbreviated Numbers](#)" on page 24, "[Dial-by-Name](#)" on page 24, "[Phone Book](#)" on page 26, and "[Call List](#)" on page 32.

Last External Number Redial

When you initiate an external call the system automatically stores all the dialled digits, irrespective of whether the call was successful or not. Stored numbers can consist of maximum 32 digits.



Press to redial the last dialled external number.

Note: You can also redial a number with the *Call List*, see section "[Call List](#)" on page 32.

Automatic Callback

You call an extension and receive busy tone or get no answer. This can also be used if no external line is free:

5

Press.

Verification tone.

Note: *The number for Automatic Callback may differ from country to country, see table "Alternative programming for Automatic Callback, Camp-on, Intrusion" on page 82.*

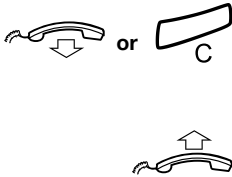

Replace the handset or press to finish the procedure.

You are called back if the extension finishes the ongoing call or the next time the extension finishes a new call. You have to answer within eight seconds otherwise the Callback service is cancelled.

Lift the handset when you are called back.

The requested extension is called automatically.

Busy extension

You call an extension and receive busy tone. The display shows:

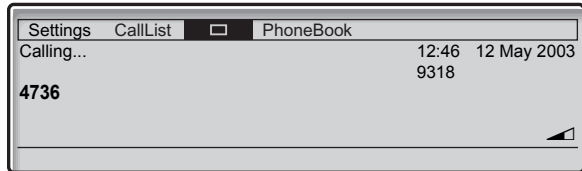

Camp-on

You can notify a busy extension of your call by a muted ringing call (if this function is allowed).

4

Press to camp-on.

Keep handset off hook. When the called extension replaces the handset it will be called automatically.

Notes:

If you receive the busy tone again, the desired extension does not allow Camp-on.

The number for Camp-on may differ from country to country, see table “[Alternative programming for Automatic Callback, Camp-on, Intrusion](#)” on page 82.

Intrusion

You can intrude on an ongoing call on a busy extension (if this function is allowed).

8**Press to intrude.**

Intrusion tone is heard and a three-party call is established. When the called extension replaces the handset and you keep off hook, the called extension will be recalled automatically.

Notes:

If you still hear the busy tone, your extension does not have the authority to intrude or the desired extension is protected against Intrusion.

The number for Intrusion may differ from country to country, see table “[Alternative programming for Automatic Callback, Camp-on, Intrusion](#)” on page 82.

Diverted Extension

Bypass Call Forwarding makes it possible to call a specific extension, even if Call Forwarding is activated on this extension.

*** 6 0 *****Dial.****Enter extension number.****#****Press.**

You will be connected to the specified extension, regardless of which type of Call Forwarding the called extension has activated.

Abbreviated Numbers

By using Abbreviated Numbers, you can make calls simply by pressing a few keys. Frequently used external numbers are stored as Common Abbreviated Numbers in the exchange.

Your personal most frequently used external numbers can be stored and used on the programmable keys on the telephone or on the keys 0 to 9.

Common Abbreviated Numbers

External numbers are stored centrally in your BusinessPhone Communication Platform. Common Abbreviated Numbers can be dialled from every extension that has the authority to do so.



Dial the Common Abbreviated Number.

Please refer to your telephone directory.

Dial-by-Name

You can program and activate directory numbers (extensions and Common Abbreviated Numbers) on the programmable keys. Stored numbers can consist of maximum 16 digits.

Head Office



Press to make a call (pre-programmed).

Program Dial-by-Name

Settings

Press the left navigation key to mark the Settings menu (see display).

Select

Press to select the Programmable Keys menu (see display).

Note: Depending on the system, some keys are pre-programmed and cannot be changed.



Press a programmable key.

Now you are asked to enter a number.



Dial the extension number or the Common Abbreviated Number.

Save Press to store the number or the code (see display).

Exit Press to return to the previous menu (see display).

Note: You can remove the transparent cover in order to write the names beside the keys. Use the Designation Card Manager to make and print your own designation cards. The Designation Card Manager is included on the Telephone Toolbox CD for the BusinessPhone Communication Platform.

Phone Book

Your IP phone is equipped with a personal Phone Book where you can make up to 100 entries (names and numbers).

PhoneBook

Select the PhoneBook tab with the Navigation keys (see display).

The Phone Book menu is displayed.

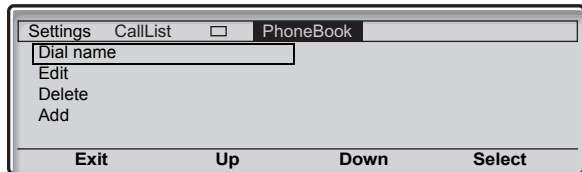

Up or Down

Press to choose a menu option (see display).

Select

Press (see display).

Dial Name

You can call someone by pressing the first character(s) of a name and then scroll the name list to search for the name and number.

Option 1:

2 - 9

Press and hold for 1 second.

Up to five Phone Book entries starting with the same letter as the letter above the key are displayed.

Call

Press to make the call (see display).

Or:

Up or Down

Press to scroll the list (see display).

Note: If you press and hold the key 2 for more than a second, up to five entries starting with A are displayed. If the search result comprises more than five entries, use the Up or Down menu key to scroll the list.

Option 2:

PhoneBook

Select the PhoneBook tab with the Navigation keys (see display).

Select

Press (see display).

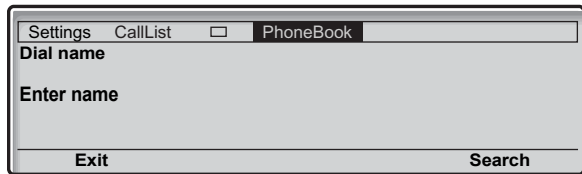

Press the key with the corresponding letter until the initial letter of the name is displayed.

Search

Press (see display).

The first name beginning with the selected character is displayed.

Up or Down

Press to scroll the list (see display).

Call

Press to make the call (see display).

Add a name and number to the Phone Book

There are several ways to add number and names to the Phone Book:

- Using the keypad (0-9), see section “[Write Text](#)” on page 70.
- Adding a Call List entry to the Phone Book, see section “[Call List](#)” on page 32.
- Browse the telephone using a standard web browser and enter the name and number.

The following text describes how to enter a name and number with the Phone Book menu and the keypad.

PhoneBook **Select the PhoneBook tab with the Navigation keys (see display).**

Down **Press to mark the Add option (see display).**

Select **Press (see display).**

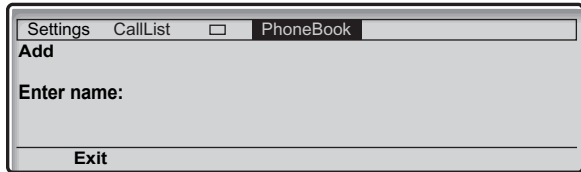

Save **Enter the name and press (see display).**

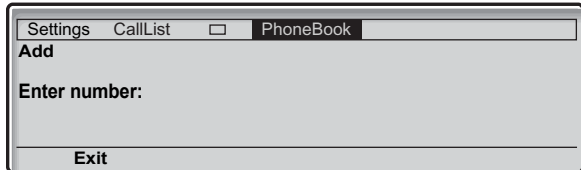

Save **Enter the number and press (see display).**

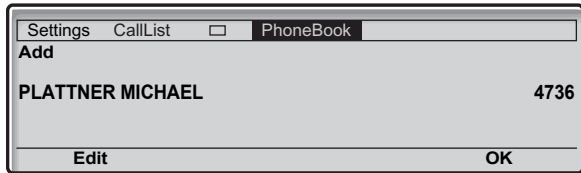

OK **Press to save (see display).**
The name and number are stored in the Phone Book.

Or:

Edit **Press to edit the name and number again (see display).**

Edit a name and number in the Phone Book

PhoneBook **Select the PhoneBook tab with the Navigation keys (see display).**

Down **Press to mark the Edit option (see display).**

Select **Press (see display).**

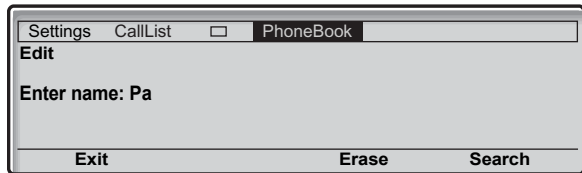

Search

Enter the first character(s) of the name and press (see display).

A list with up to five entries appears. The first name beginning with the selected characters is marked. To correct a typing error, just press Erase.

Up or Down **Press to scroll the list (see display).**

When the entry is found and marked with a frame:

Select **Press to select the marked name (see display).**
The Edit menu opens.

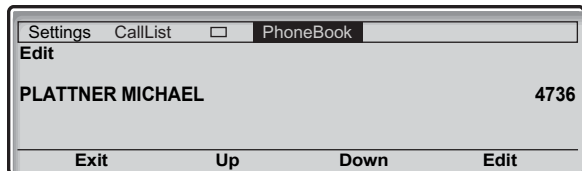

Edit **Press (see display).**

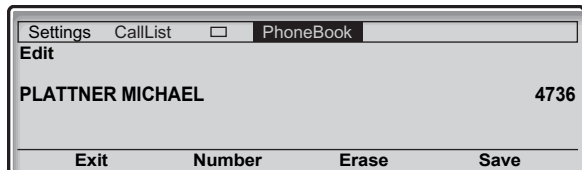

Erase **Press multiple times to erase the name (see display).**
Each time you press the Erase menu key, one character is deleted.



Save

Enter the new name completely and press (see display).

Number

Press (see display).

The cursor moves to the end of the number.

Erase

Press multiple times to erase the number (see display).

Each time you press the Erase menu key, one digit is deleted.



Save

Change the number and press (see display).

OK

Press to save (see display).

The edited name and number are stored in the Phone Book.

Or:

Edit

Press to edit the name and number again (see display).

Delete a name and number in the Phone Book

PhoneBook

Select the PhoneBook tab with the Navigation keys (see display).

Down

Press (see display).

Press until Delete is marked in the display.

Select

Press (see display).

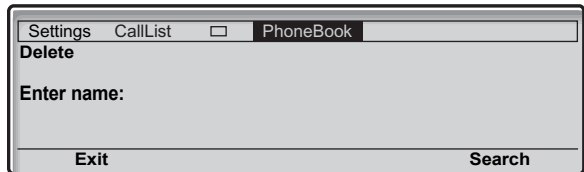

Search

Enter the first character(s) of the name and press (see display).

A list with up to five entries appears. The first name beginning with the selected characters is marked.

Up or Down

Press to scroll the list (see display).

When the entry is found and marked with a frame:

Delete

Press (see display).

The name and number that will be deleted are shown in the display.

OK **Press to delete the name and number (see display).**
The name and number is deleted from the Phone Book.

Or:

Cancel **Press to abort (see display).**

Call List

Your incoming calls (answered, missed and rejected) and outgoing calls are stored in the Call List. The calls in the Call List can also be added to the Phone Book, see section “Phone Book” on page 26. Up to 50 calls can be stored in the Call List.

Note: *If a power failure occurs or another user logs on, the Call List will be cleared.*

Redial from the Call List

CallList

Select with the navigation keys (see display).

The display shows the Call List entries sorted by date and the call duration (hours, minutes, seconds). For example:

Settings	CallList	PhoneBook
[←] PLATTNER MICHAEL	4736	12:33 12 May 0:00:07
[←] BECKER SANDRA	8336	12:33 12 May 0:00:07
[←] BROWN BOBBY	9702	12:33 12 May 0:00:07
[←] SANDMAN MARIA	1335	12:33 12 May 0:00:07
[←] HASLINGER WOLFGANG	6068	17:07 11 May 0:00:50
more...	Up	Down Call

If the list is too long and cannot be displayed at a time, a scroll bar appears on the right side of the display.

Up or Down

Press to browse the CallList (see display).

The digit in brackets shows the entry position in the list.

Call

Press to call (see display).

Or:

more...

Press to get more options (see display).

The edit menu is displayed.

Edit menu options:

Settings	CallList	PhoneBook
PLATTNER MICHAEL	4736	12:33 12 May 0:00:07
BECKER SANDRA	8336	12:33 12 May 0:00:07
BROWN BOBBY	9702	12:33 12 May 0:00:07
SANDMAN MARIA	1335	12:33 12 May 0:00:07
HASLINGER WOLFGANG	6068	17:07 11 May 0:00:50
Exit	Back	Delete AddPhoneBook

Exit Press to return the normal display (see display).

Or:

Back Press to return to the previous menu (see display).

Or:

Delete Press to delete the call from the Call List (see display).

Or:

AddPhoneBook Press to add the number to the Phone Book (see display).
See section ["Add missed, rejected, answered or dialed calls to the Phone Book"](#) on page 34.

Missed/Rejected calls

The number of missed calls is shown in the bottom line of the Home menu in idle mode:

Settings	CallList	PhoneBook
		12:46 12 May 2003 9318
Log off	1 Missed	

1 Missed Press (see display).
The digit indicates the number of missed calls, in this example one. Now the Call List menu is displayed.

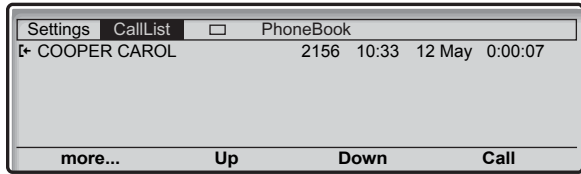

Note: You can also enter the Call List by selecting the Call List menu with the navigation keys.

Call Press to call (see display).

Or:

more... Press (see display).

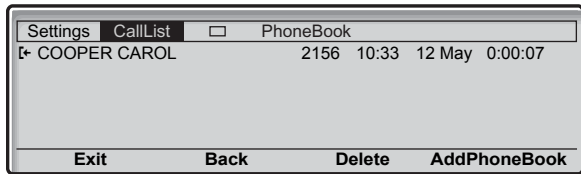

Add missed, rejected, answered or dialled calls to the Phone Book

CallList Select with the navigation keys (see display).

Down or Up Press to browse the CallList (see display).

more... Press (see display).

AddPhoneBook Press (see display).

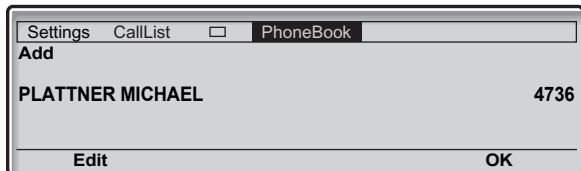

OK **Press to add the call to the Phone Book (see display).**

Or:

Edit **Press to edit the number before you add it to the Phone Book (see display).**

Via the display options you can change or erase the name and number before you add it to the Phone Book.

How to edit an entry and for further information, see sections [“Phone Book”](#) on page 26 and [“Write Text”](#) on page 70.

Delete an entry from the Call List

- CallList **Select with the navigation keys (see display).**
- Down or Up **Press to browse the CallList (see display).**
- more... **Press (see display).**
- Delete **Press (see display).**
The selected entry will be deleted.

During Calls

The BusinessPhone Communication Platform allows you to handle calls in many different ways. You can switch between handset and handsfree/group conversation, mute the microphones, make an inquiry, transfer the call, create a Conference or put the call on hold to perform other tasks.

Group Listening

You have an ongoing conversation via the handset.

Note: You can adjust the volume, see section "[Handset and loudspeaker volume](#)" on page 74.



Press to switch the loudspeaker on or off.

When the lamp lights, the loudspeaker monitors the call.

From handset to handsfree

You have an ongoing conversation via the handset.



Press to switch the loudspeaker on.

You are now in the group listening mode.



Replace the handset.

Handsfree conversation.

Note: You can adjust the volume, see section "[Handset and loudspeaker volume](#)" on page 74.



Press to end the call.

From handsfree to handset



You have an ongoing handsfree conversation.

Lift the handset.

Conversation via the handset.

Mute



You have an ongoing conversation.

Press to switch the microphone on or off.

When the lamp lights, the caller will not be able to hear the conversation in your room.

Inquiry

During an ongoing conversation you would like to make an inquiry to an internal or external party.



Press the Line key.

The first call is put on hold. Enter the number of the person you would like to ask.



When you have finished your inquiry:

Press.



Press the Line key with the call on hold.

Now you are connected to the first caller.

Transfer

You have an ongoing internal or external conversation and you want to transfer the ongoing call.



Press.

Call the third party.

You can transfer the call before answer or wait for answer

Note: Make sure, that you are connected to the desired party. Please read the notes and warnings in section "[Useful Hints](#)" on page 86.



Replace the handset.

The call is transferred.

Transfer to a busy extension

You can even transfer calls to busy extensions. The other party will hear a muted signal (camp-on), and the call will be extended, as soon as the ongoing call is terminated (if Camp-on is allowed).

Callback

You are called back, if you have transferred an external call and the other extension has not answered the call within a certain time. Your telephone will ring again.

Call Waiting

If you hear the Call Waiting tone during an ongoing conversation, another person is trying to contact you.

To terminate the ongoing call and answer the waiting call

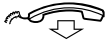

Replace the handset to finish the ongoing call.

The waiting call is signalled on your phone.



Lift the handset to answer the new call.



Or:

Press and replace the handset to answer in handsfree mode.

Conference

You have an ongoing conversation and you want to establish a telephone conference.



Press.



Call the third party.



Press to establish a three party conference.

Now you have established a three party conference. To mark the conference, all conference members will hear a periodical conference tone.

Repeat the procedure to include other persons to the conference.

In this way, you can include up to six parties in a conversation. How many of them can be external callers depends on the programming of the system.



Replace the handset to leave the conference.

Individual Hold

You have an ongoing conversation. Now you want to put the ongoing call on hold for a short while.



Press the Line key.
The lamp flashes slowly.



Replace the handset.



Press again to retake the call that has been put on hold.

Common Hold



Press to pick-up on own extension.

Or:

Pick-up on another extension:



Call the extension that put the call on hold.

6 **Press.**

Call Forwarding

When you are not available to take calls or decide to answer your calls on another extension, it is useful to forward your calls to an alternate answering position.

If you urgently need to talk to someone who has forwarded his calls, the system is also equipped with a bypass function.

Depending on the type of diversion you are also able to record your Personal Greeting, see section “[Personal Greeting](#)” on page 51.

Note: *You can still make calls as usual.*

Diversion when there is no answer

If you are not available to answer incoming calls (internal or external), your system administrator can program your extension to automatically divert calls to a programmed diversion address (default time: 15 seconds).

Diversion when caller receives busy tone

If your extension is busy and you receive an incoming call (internal or external), your system administrator can program your extension to automatically divert the call to a programmed diversion address.

Fixed Diversion

This function directs your calls to a pre-programmed answering position (e.g. secretary).

Activate Fixed Diversion

*** 2 1 #**

Dial to activate diversion.

Cancel diversion

2 1

Dial to cancel diversion.

Individual Diversion

This feature gives you the possibility to divert your calls to internal and external positions, e.g. to any directory number, a colleague's extension, an external number or a common abbreviated number (e.g. your car telephone).

Note: *In order to prevent misuse, Individual External Diversion can be blocked for your extension, see section "Security" on page 58.*

Program and activate Internal Diversion

Divert your calls to an internal position.

*** 2 1 ***

Dial.



Enter the new directory number.

#

Press to activate the Individual Diversion.

Verification tone. You can make outgoing calls as usual. A special dial tone reminds you that Call Forwarding is active.



Press to finish the procedure.

Note: *An Individual Internal Diversion cannot be activated if an Individual External Diversion is already activated.*

2 1

 C

Dial.

Press.

Cancel Internal Diversion

Program and activate a new External Diversion address

To set a new Individual External Diversion address:

*** 2 2 ***

0 

Dial the digit(s) for external call access and enter the new External Diversion address.

A maximum of 24 digits.

Note: *If your public network requires waiting for a second dial tone, press *.*

#

 C

Press to activate the Individual Diversion.

Verification tone.

Press to finish the procedure.

Note: *Before you leave, call your extension to check if the External Diversion has been set up correctly. This way you can make sure that the number has been programmed properly and that your calls will not be diverted to another person by mistake. Individual External Diversion can also be used via the DISA function, see section "Other Useful Features" on page 64.*

2 2

 C

Dial.

Press.

Cancel External Diversion

Note: *The programmed diversion address is not removed from the memory, the diversion is just inactive.*

Re-activate External Diversion

Divert your calls to an external position.

*** 2 2 * #**



Dial to activate the programmed External Diversion.

You can make outgoing calls as usual. A special dial tone reminds you that call forwarding is active.

Press.

Follow-me

If you are in another room, you can still answer your calls by forwarding them to where you are. To activate Follow-me, Individual Diversion must be active on your telephone.

Activate Follow-me

Note: *This procedure has to be executed from the telephone the calls are diverted to.*

*** 2 1 ***



Dial.

Dial your number and press.

Dial the new number and press.

Special dial tone.

Press to finish the procedure.

Special dial tone.

Cancel Follow-me

Follow-me and Individual Diversion can also be cancelled from the answering position.

2 1 *



#



Dial.

Dial your number.

Press.
Dial tone.

Press to finish the procedure.
Dial tone.

Absence Information

If you are not in the office for a certain period of time (e.g. meeting, vacation, lunch, illness), this feature allows you to inform your callers why you are absent. External callers will be routed to the operator who also has access to your absence info.

Note: *When you have activated a diversion with a Personal Greeting, callers will receive this greeting even if you have activated the Absence Information, see section “[Personal Greeting](#)” on page 51.*

You can inform your callers with:

1) Pre-defined texts

Enter the reason for your absence and the date and time of your return.

2) Voice information

Record a voice message and name the reason of your absence.

Enter information

To store text or voice information.

*** 2 3 ***

Dial to enter the information mode.

Select Pre-defined Text or Voice Information.

Pre-defined texts



Enter Code.



Enter Completing Info from the table below.

	Code	Completing Info
Time of return	1	hour (00-23) minute (00-59)
Date of return	2	month (01-12) day (01-31)
Lunch	3	back at, hour minute
Meeting	4	back at, hour minute
Vacation	5	back, month day
Illness	6	back, month day

#

Press to enter the information.

Internal callers receive the information on the display (or as spoken information to callers without display phone).

External callers will be routed to the operator who also has access to your absent info.



Press to finish the procedure.

Pre-defined texts example:

Vacation, back June 27

*** 2 3 ***

Press.

5

Enter code.

0 6 2 7

Enter month and day.

#

Press.

Information active.



Press to finish the procedure.

Voice information

*** 2 3 ***

Press to enter information mode.

9

Press and speak.

Press to play-back and listen to your recording.

9

Press and speak to re-record.

#

Press to activate.



Press to finish the procedure.

Internal callers will hear the information via the handset or the loudspeaker. External callers will be routed to the operator who also has access to your absence info.

Note: *You can dial your own extension number if you want to check your information.*

Change information

Erase

2 3

Press to erase info.



Press to finish the procedure.

Save

* 2 3 * #

Press to deactivate and save for later use.

Information is passive.



Press to finish the procedure.

Use saved information

When the information is switched off:

* 2 3 * #

Press to activate saved info.

Information is active.



Press to finish the procedure.

Messages

By using the Message system you can send, receive, forward, and store different kind of messages. You have also access to a number of helpful features, like placing external calls via the company network and many more...

Password protection

The first time you enter the Message system (only possible from own extension) you might be requested to change your Password if it is default (0000).

Note: *Some systems are programmed to allow the default Password. Please note that this password refers to the BusinessPhone Communication Platform, not to the general log on procedure of the IP telephone for usage. To log on with the IP telephone to the system, you need another password from your system administrator. See section “[Log On / Log Off](#)” on page 15.*

Follow the voice announcements.

You are requested to enter a new Password, confirm and save it. If you use the default Password, you are requested to try again.



Replace the handset to finish the procedure.

Or:

Continue with any of the message functions.

If you want to change your Password again, it is possible from the Message system or via the function “[Change Password](#)” on page 58.

Individual Mailbox system

Callers are able to leave messages in your Individual Mailbox.

Activate

Divert your extension to the Mailbox system.

*** 2 1 ***



Dial.

Dial the number to the Mailbox system.

Please ask the system administrator for your defined Mailbox system number.

#

Press.



Press to finish the procedure.

Deactivate

2 1

Dial.



Press to finish the procedure.

Personal Greeting

Depending on the type of diversion you want to activate, you can leave three different Personal Greetings to the caller. The diversion state can be on no reply, on busy or an activated Individual Diversion.

*** 5 9 #**

Dial.

During the procedure you will be asked for your extension number and your Password.

2

Press to configure your Personal Greeting.



Enter diversion code.

Select an option below and follow the voice announcements.

Type of diversion	Code
Diversion greeting on busy	1
Diversion greeting on no reply	2
Individual Diversion greeting	3

#

Press to store the recorded greeting.

When you activate the diversion, the recorded greeting is played to the next caller.



Press to finish the procedure.

Note: *When you have activated a diversion with a Personal Greeting, callers will receive this greeting even if you have activated the Absence Information, see section “Absence Information” on page 46.*

Retrieve messages internally

When you lift the handset and receive a special dial tone.

* 5 9 #

Dial.

See section “[Check and store received messages](#)” on page 54.

Retrieve messages - externally

To retrieve your messages from an external position:



Dial your company's telephone number.



Dial the number to the Mailbox system.

During the procedure you will be asked for your extension number and your Password.

Note: *You cannot use the Default Password 0000 to retrieve messages externally. If you want to check your messages from an external position, you have to change your Password first, see section “Change Password” on page 58.*

The following Mailbox functions can also be used from an external position:

- Change Password
- Check and store received messages

- Forward a Voice message
- Send Message
- Outcall (External) Notification
- Personal Greeting

Outcall (External) Notification

With this function the Message system can notify you when new Voice messages arrive. You can specify an external number, where you will be called at a pre-programmed time or as soon as a new message arrives.

Note: *This feature may be restricted or not available. Ask the system administrator for the availability and for more information.*

You can be notified in two different ways (depending on the programming of the system):

Notification with Mailbox access:

You acknowledge the notification via your Password (has to differ from the default value 0000). See section “[Change Password](#)” on page 58 to select a new Password. You have full access to the Mailbox system.

Notification without Mailbox access:

You get a short voice announcement, informing that someone has left a message for you. You acknowledge the notification by pressing any key and you have to call back the Mailbox system in order to retrieve the message.

Note: *If you do not acknowledge the notification within the pre-programmed time, the connection is cancelled and repeated later (ask the system administrator for the programmed number of notification attempts).*

Programming

✖ 59 #

Dial.

Note: *Depending on the configuration, you might be asked for your Password.*

Follow the voice announcements.

You can program the external notification number, the notification time and activate/deactivate the function. The external number (including the digit(s) for external call access) can consist of up to 24 digits. The time is entered in 24h-format, e.g. 2030 for half past eight with values automatically set to even quarters, i.e. 2013 will be 2015.

Note: *The notification number and time must be programmed before you activate the notification.*



Press to finish the procedure.

Check and store received messages

You can check and store your received messages.

Received messages are divided into following three categories:

- New messages (not heard)
- Heard messages
- Stored messages

Voice messages can also be forwarded to other Mailbox numbers (individual or common), see section “[Forward a Voice message](#)” on page 55.

Note: *Messages are deleted from the system after a certain time. The time depends upon the category of the message. Please ask your system administrator regarding this.*

*** 5 9 #**

Dial.

You can check and store your received messages. Up to 20 messages can be stored.

Voice messages will be heard via the speaker or the handset. Call Me messages will call the sender automatically (these messages cannot be stored).

Note: *Depending on the configuration, you might be asked for your Password before you can retrieve your messages. See section “[Security](#)” on page 58.*



Press to finish the procedure.

Forward a Voice message

Your received Voice messages (in the Individual Mailbox) can be forwarded to other Mailbox numbers (Individual or Common). When you forward a Voice message to an Individual Mailbox, the Mailbox number is the same as the extension number.

✖ 59#

Dial.

Note: *Depending on the configuration, you might be asked for your Password before you can retrieve your messages. See section "Security" on page 58.*

Follow the voice announcements.

You can forward new, heard or stored Voice messages.

Note: *The forwarded message is a copy, i.e. it can be deleted without deleting the original message.*

Repeat the procedure to forward the message to another Mailbox.



Press to finish the procedure.

Send Message

To send a message to an extension when you receive busy tone or get no answer.

Callback message

To send a Call Me message.

9 # Press to send.

Voice message

To send a Voice message.

9 9 Press and speak.

✖ Press to play-back and listen to your recording.

9 Press and speak to re-record.

Press to send.

Dictaphone function

If you want to record and retrieve personal Voice messages you can use the Dictaphone function. A Dictaphone message is treated as a normal message. How to retrieve Dictaphone messages, see section "[Check and store received messages](#)" on page 54.



*** 5 8 #**

Record message

To start the recording:

Lift the handset.

Dial and record your message.

The maximum recording time is four minutes and 15 seconds.

Select options below:

Press to play-back.

9

Press and speak to re-record.

#

Press to stop the recording and save the message.

Security

You can use your four-digit Password for blocking your phone from unauthorized use, for making external calls from any blocked extension, for entering the Message system or when you are using the DISA function.

Note: *The first time you enter the Message system you might be requested to change your Password if it is default (0000). This procedure is performed directly in the Message system. See section “[Messages](#)” on page 50.*

Change Password

* 7 2 *

Dial to select a new Password.



Dial your present Password.
The default Password is 0000.



Press.



Dial your new Password.



Press.
Verification tone.



Press to finish the procedure.

Bypass blocked extension

In order to make a call, you can temporarily bypass a blocked extension.

Bypass own extension

*** 7 2 ***

Dial.

⦿⦿⦿
⦿⦿⦿
⦿⦿⦿
⦿

Dial your Password.

#

Press.

Dial tone. You can make one call from your extension.

Bypass another extension

This makes it possible to make a call on another, blocked extension, by using your Password.

*** 7 2 ***

Dial.

⦿⦿⦿
⦿⦿⦿
⦿⦿⦿
⦿

Dial your Password.

Press.

⦿⦿⦿
⦿⦿⦿
⦿⦿⦿
⦿

Dial your extension number.

#

Press.

Dial tone. You can make one call from the blocked extension.

Block extension

***72#**



Dial to block your extension.
Verification tone.

Press to finish the procedure.

Unblock extension

#72*



#



Dial.

Dial your Password.

Press to re-open.

Verification tone. Your extension is open for use.

Press to finish the procedure.

Group Features

When you are working together in a team the following group facilities can be very useful.

Group Call-pick-up

In a Pick-up group, any member can answer any individual call to group members. You answer a call to the group by dialling a special answering number. Please ask your system administrator for the configured number.



Dial the group Call-pick-up code.

Common Bell

The Common Bell function allows all extensions of the system (operator included) to pick-up the call from an extension that has been predefined as a Common Bell extension.



Dial the Common Bell pick-up code.

Please ask your system administrator for the Common Bell pick-up code.

If two or more extensions simultaneously attempt to answer a call from the Common Bell extension, only the first extension will pick it up. The other extensions will receive the number unobtainable tone. This will also happen if you dial the Common Bell pick-up code and there are no calls waiting at the Common Bell extension.

Note: *You can also program the Common Bell code on a Function key.*

Group Hunting

Your telephone can be included in one or several hunt groups. In a hunt group all members are represented with one common directory number. 16 hunt groups can be programmed, each containing 1 to 20 members. A member can be either an extension number, an operator console or a fictive number. Please ask your system administrator if you require this function.

Note: *The number of cordless extensions in a hunt group are limited to eight (including Tandem configurations).*

Incoming calls to the hunt group are directed to free extensions in the group. The hunt order within the group can be changed to suit your needs. If all members of the hunt group are busy, an incoming call is being queued. If no one answers this call before the programmed time, the call is forwarded to the programmed answering position (e.g. operator).

Note: *If all members in a hunt group are busy, the Callback or Intrusion function is not available.*

Log in

Before you can answer group hunting calls, you must log in.

To log in to one hunt group:

*** 2 8 ***

Dial.



Dial the hunt group code.

Please ask your system administrator for the configured number.

#

Press.

To log into all hunt groups:

*** 2 8 ***

Dial.

*** #**

Press.

Answer calls

Answer Group Hunting calls in the normal way.

Log out

2 8 *

Dial.



Dial the hunt group code.

Please ask your system administrator for the configured number.

#

Press.

To log out from all hunt groups:

2 8 *

Dial.

*** #**

Press.

Other Useful Features

By using these features your productivity will be increased, e.g. you can set reminders for important meetings, place the cost for external calls on separate accounts, listen to music via the loudspeaker and much more...

Tandem configuration

The Tandem configuration is a unit, consisting of two telephones using the same directory number. One of the telephones is defined as the *primary* and the other one as the *secondary*. This function enhances the communication for users that, for example, have a wired phone on their desk (the *primary telephone*) and need to be mobile within their company's building with their own portable (the *secondary telephone*). Basically the Tandem configuration works as follows:

To activate the Tandem configuration

✳ 2 8 #



Dial to log on the secondary telephone.

Press to finish the procedure.

For incoming calls:

- Both telephones are treated as 1 single extension.

For outgoing calls:

- Both telephones are treated as 2 separate extensions.

2 8 #**To deactivate the Tandem configuration****Dial to log off the secondary telephone.**

For incoming calls:

- The *secondary* telephone cannot be called and the *primary* telephone works as a normal stand-alone telephone.

For outgoing calls:

- Both telephones are treated as 2 separate extensions.

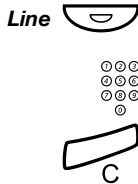
Transferring a call between members of a Tandem unit

Press.

Dial own directory number.

Press to finish the procedure.

Reminder

The phone can be set to remind you at any time within the next 24 hours (multiple settings are allowed).

*** 3 2 ***

Dial.

Dial Reminder time and press.

(00-23) hour + (00-59) minute. When the time is reached your phone rings with recall signal.

Note: *If you receive busy tone, your extension does not have the authority to set a Reminder.*



Press to finish programming.

When the Reminder time is reached, your phone rings with recall signal.

3 2



Cancel Reminder

Dial to cancel all settings.

Press to finish the procedure.

Doorphone

The Doorphone is used to monitor the admission to your company, i.e you can open the doorlock from your phone.



Answering Doorphone calls

Lift the handset.

You will be in speech connection with the calling party.

Opening of the doorlock

After you have answered the Doorphone, you can open the door making an inquiry to the door-opener's directory number.

Line 



Press.

Dial the door-opener's directory number.

Please ask your system administrator for the number.

Note: *You can also program the door-opener's directory number as a Common Abbreviated Number or a Function key.*

Direct Inward System Access (DISA)

If you are working externally and you have the need to make business calls, call your company and use the company PBX to make an external call to the desired party. You just pay the costs for the phone call to your company. The other costs will automatically be placed on your extension number or on a special project.

Note: To activate this function, you have to change the default Password from 0000 to a personal one. Which code to use and how to change it, see section [“Change Password”](#) on page 58.

You can also divert calls from your office extension to your external position, see section [“Call Forwarding”](#) on page 41. During the procedure you will be prompted for your Password.

⓪⓪⓪
⓪⓪⓪
⓪⓪⓪
⓪

Dial the public number of your company.

⓪⓪⓪
⓪⓪⓪
⓪⓪⓪
⓪

Followed by the DISA number.

Ask the system administrator for the defined DISA number.

Note: If you want to register the call on an Account Number, you should use the Account Number procedure before you enter the external number, see section [“Account Number”](#) on page 68.

⓪⓪⓪
⓪⓪⓪
⓪⓪⓪
⓪

Dial the external number.

Or:

Use the External Diversion function.

Procedure, see section [“Call Forwarding”](#) on page 41.

Note: If you program a new diversion address, remember to reset it when you return to your office.

Account Number

An Account Number can be entered to debit telephone costs to different accounts. Depending on the system configuration the Account Number has to be entered from a Verified Account Number list (predefined) or you can invent an own Account Number. The following prerequisites apply:

- With the Verified Account Number you can restrict the making of external calls (not a specific number or area), so everyone who is allowed to make external calls will receive an Account Number which has to be used each time he/she wants to make an external call.
- Verified Account Numbers contain up to 10 digits.
- Own Account Numbers contain up to 15 digits.

The Account Numbers can also be used via the DISA function, see section "[Direct Inward System Access \(DISA\)](#)" on page 67.

Verified or own Account Number

Before an outgoing call:

✖ 9 ✖

Dial.

⊙⊙⊙⊙
⊙⊙⊙⊙ #
⊙

Enter Account Number and press.

Valid digits 0-9. Internal dial tone. Make the external call.

DTMF Tones

The DTMF function - also known as Suffix Dialling - is used to control answering machines or any other telecommunication devices. This function is permanently active during a call.

⊙⊙⊙⊙
⊙⊙⊙⊙
⊙⊙⊙⊙
⊙

Make an internal or external call to reach the desired device.

When your call is answered you can continue to dial digits which will be sent as DTMF digits (tone signals) to the called device in order to activate the desired functions.

Least Cost Routing

Least Cost Routing (LCR) automatically selects the cheapest way to establish the connection to the desired external number. Please ask your system administrator if this function is installed in your system.

If the extension has been configured to use LCR, each external call will be analysed and the cheapest way will be selected.

Use Least Cost Routing

0 

Dial the digit(s) for external call access and the external number.

The usual way of making an outgoing external call.

Calling Least Cost Routing

If LCR has been installed in your system, but your extension is not configured to use it automatically, you also have the opportunity to get the cheapest connection by dialling the LCR code before you dial an external number.



Dial the LCR code.

Please ask your system administrator for the LCR code.

0 

Dial the digit(s) for external call access and the external number.

***Note:** You can also program the LCR code on a Function key.*

Write Text



It is necessary to write text, e.g. when you want to add an entry to the integrated telephone directory.

Select characters by pressing digits repeatedly.

Additional, the available characters of a key are displayed below the name and number:

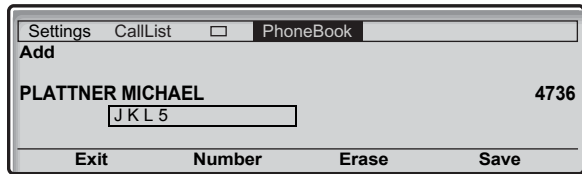

Example:

5

Press a digit.

- 1 time result J
- 2 times result K
- 3 times result L
- 4 times result 5

Note: Key **1** is reserved for special characters.

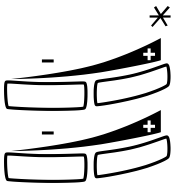

Press to toggle between upper and lower case.

Press the Volume Up key to enter the character.

Moves cursor to next position. Use also for space.

Press the Volume Down key as backspace to erase incorrect entry.

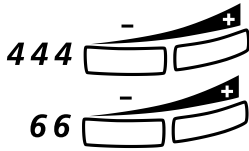

Example:

Enter the first character code, followed by the Volume Up key.

This sequence - numbers always followed by the Volume Up key - gives the word IN_ .

Note: You can also write the following characters:

? -, !: /# *

✱

Press repeatedly.

Settings

In order to satisfy your personal needs, the BusinessPhone Communication Platform and your IP telephone are equipped with many options for an individual configuration.

If you require frequent use of certain functions, you may program them on the function keys of your telephone. To use the function, just press the key.

Notes: Remove the transparent cover in order to write the name beside the key. Put the name referring to the programmed function in the field above the line to indicate that it is the primary function. If a function is already programmed on the key, this will be displayed when you start programming.

The following settings and programmable functions are available when you have logged on to your IP telephone:

- Data assigned to programmable keys
- Ringing character setting
- Time and date (format)
- Language settings
- Hearing level
- Name and numbers in the phone book
- Display the network settings

When you select a setting on the left side, the display will show additional information, for example:

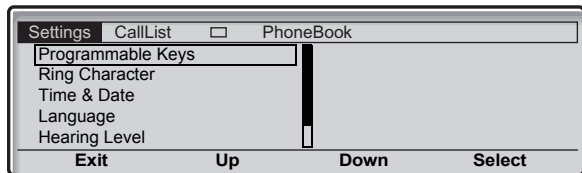

Settings menu options:

Exit	To return to the previous menu.
Up or Down	Press to browse through the menus (see display).
Select	Press to select the menu option marked on the left side of the display (see display).
Save	Press to save a setting (see display).
Cancel	Press to abort the process (see display).

Program a function

How to program a function.

Settings	Select with the navigation keys (see display).
Select	Press to select Programmable Keys (see display). The programmable keys format menu is displayed.

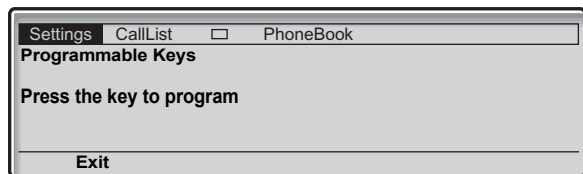

Press the desired programmable key.
If the key has been programmed previously, the function or telephone number programmed is shown in the display.

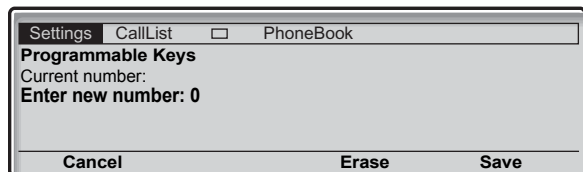



Save

Exit

Exit

Dial a code (2 digits).

Press to store the code (see display).

Press to return to the previous menu (see display).

Note: *If you want to delete the last entered digit, press Erase once. If you want to delete the complete number, press Erase until no number is displayed.*

Press again to exit to the settings menu (see display).

Handset and loudspeaker volume



Use the volume keys to change the volume of the handset or loudspeaker during a call.

Press to change the volume.

Note: *You can also set the hearing level of the handset via the settings menu. Two different levels are available.*

Ringling signal volume



You can control the ringing signal volume when the telephone is idle or when the telephone is ringing.

Press to change the volume.

Ringing signal character

There are 10 different programmable ringing signal characters on your telephone, each corresponding to a digit between 0 and 9.

Settings **Select with the navigation keys (see display).**

Down **Press to display the Ring Character menu (see display).**

Select **Press to select ring character (see display).**
The ring character menu is displayed.

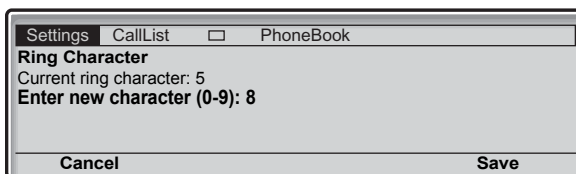

Press the corresponding digit (0-9).

The telephone rings with the chosen character.

Save **Press to store the character and return to the previous menu (see display).**

Cancel **Press to abort the process without saving (see display).**

Exit **Press to return to the previous menu (see display).**

Hearing aid compatibility and hearing level

Since your telephone has a built-in inductive coupler for the hard-of-hearing, anyone so desiring can use the telecoil in his/her hearing aid while telephoning.

You can also increase the hearing level to +6 dB in the handset and headset:

- Settings **Select with the navigation keys (see display).**
- Down **Press to mark the Hearing Level menu (see display).**
- Select **Press (see display).**

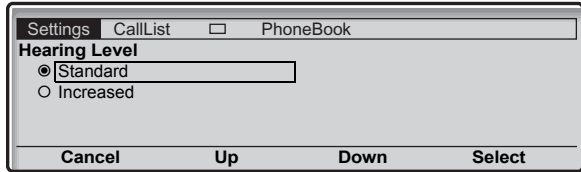

- Up or Down **Press to toggle between the two values (see display).**
- Select **Press to select the highlighted format (see display).**
- Exit **Press to return to the previous menu (see display).**

Time and Date

The time and date is updated by the exchange automatically. You can only set the date and time format.

Note: *The Time and Date functions require certain installation options. If you are unable to change the time and date format please contact your system administrator.*

To set the time format

- Settings **Select with the navigation keys (see display).**
- Down **Press to mark the Time & Date menu (see display).**
- Select **Press to open the menu (see display).**
The Time Format menu is displayed.

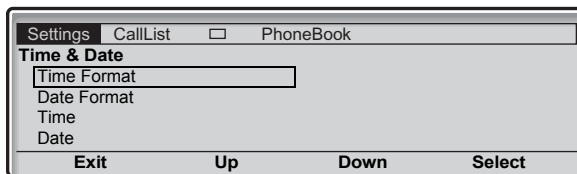

- Select **Press to select Time Format (see display).**
Two time formats are available: 24 hour mode and 12 hour mode.

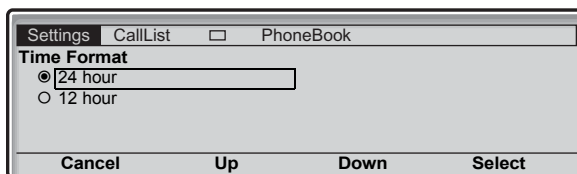

- Up **Press to change the time format (see display).**
- Select **Press to select the highlighted format (see display).**

To set the date format

- Settings **Select with the navigation keys (see display).**
- Down **Press to mark the Time & Date menu (see display).**
- Select **Press to open the menu (see display).**
- Down **Press to mark the Date Format option (see display).**

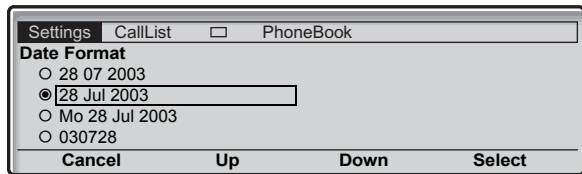

- Up or Down **Press to browse through the different formats (see display).**
- Select **Press to select the highlighted format (see display).**
- Exit **Press to return to the previous menu (see display).**

Language

Note: *If this function is not available, please contact your system administrator.*

To change the language:

- Settings **Select with the navigation keys (see display).**
- Down **Press to mark the Language menu (see display).**
- Select **Press to display the Language menu (see display).**

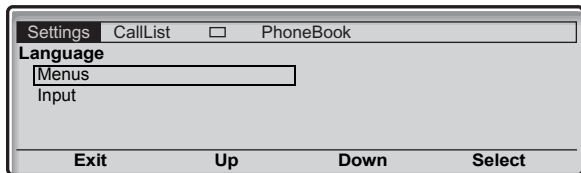

- Select **Press to select the Display Menu option (see display).**
The language format menu is displayed, showing the available languages, for example:

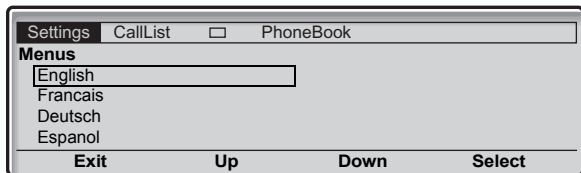

- Up or Down **Press to browse through the different language settings (see display).**
- Select **Press to select the marked language (see display).**
- Exit **Press to return to the previous menu (see display).**

Network settings

You can check the telephone's network setting in the Network menu.

Settings **Select with the navigation keys (see display).**

Down **Press to mark the Network menu (see display).**

Select **Press (see display).**

The following network options are available for viewing only:

- DHCP
- IP Address
- Subnet Mask
- Default Gateway
- SW server from DHCP
- SW server
- Proxy Server
- Gatekeeper Discovery
- Gatekeeper
- Password (IP telephone)

Note: *If you have a question concerning your network settings, please consult your system administrator.*

Exit **Press to return to the previous menu.**

Password menu presentation

If you do not use a password, you can disable the password menu. This means that you are not asked to enter a password each time the telephone registers on the network.

Note: *If you do not enter a Password during the log on procedure, you cannot access the Password menu of the telephone.*

Settings	Select with the navigation keys (see display).
Down	Press to mark the Network menu (see display).
Select	Press (see display).
Down	Press to mark the Password menu (see display).
Change	Press (see display).
Exit	Press to return to the previous menu.

Note: *If the system requests a password for an extension number, and the password presentation menu is set to no, the password menu will occur anyhow in the telephone.*

Alternative programming for Automatic Callback, Camp-on, Intrusion

The associated number for using the Automatic Callback, Camp-on or the Intrusion function may vary from country to country. If you cannot use a code of a function, maybe your exchange system has been programmed with a different associated number.

Because this User Guide describes only the default programming, the following table shows the most common settings in some of these countries that are known for a different programming.

	<i>Austria, Belgium, Brazil, Denmark, Germany</i>
<i>Camp-on</i>	5
<i>Automatic Callback</i>	6
<i>Answer calls, another extension</i>	8
<i>Intrusion</i>	4

Accessories

This chapter describes optional features that can be used together with your BusinessPhone telephone.

Headset

How to install the headset, see section “[Installation](#)” on page 87. You can set your IP telephone to headset preset mode. This way you can make calls without lifting the handset.

Activate headset preset mode



When the headset preset mode is turned off:

Press and hold the Headset key for 4 seconds.

Now the Headset preset mode is activated. All calls can be handled via the headset.

Deactivate headset preset mode



When the headset preset mode is turned on:

Press and hold the Headset key for 4 seconds.

The Headset preset mode is deactivated.



Answer calls

If the headset preset mode is deactivated:

Press the Headset key.

If the headset preset mode has been activated:



Press the flashing Line key to answer.



Press to terminate a Headset call.



Make calls

Press the Headset key.

Note: You do not need to press the Headset key in headset preset mode.



Dial the number.



Press to terminate the call.



Headset to handset

Lift the handset.



Handset to headset

Press the Headset key.



Replace the handset.



Headset with Group Listening

Press to toggle between headset with or without Group Listening.



Headset to handsfree

Press.



Press the Headset key.



Handsfree to headset

Press the Headset key.

Useful Hints

Connections between external lines

With your BusinessPhone, you can establish an external call diversion or a conference with more than one external party or transfer an external call to another external destination (e.g. a mobile phone). These features are very useful for everyday business life.

Note: *When these features are used, your BusinessPhone will occupy at least two external lines.*

However, there may be disadvantages in connecting to several external lines. We would therefore like to draw your attention to the following:

- **Please do not transfer external calls to an external mailbox, to information systems or to external parties before they have answered.**
- **Try to avoid diverting calls to third parties before they have answered.**
- **If you are connected to two external lines, cancel one call by pressing Line and 1.**

If the external parties are not persons (mailbox, automated information or attendant systems, etc.), connections on external lines can last a long time, which can be costly. Moreover, such calls may occupy two of your system's external lines. You can restrict connections between the external lines by re-programming your system.

Please ask your system administrator or contact our service center for more information.

Installation

Configuration

When the Dialog 4425 IP Vision has been connected to a power supply and to the IP network (LAN), the display will show:

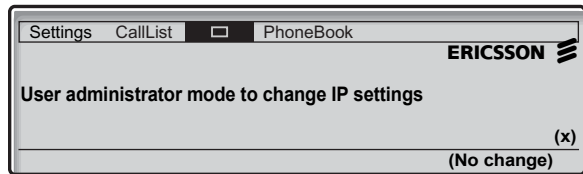

The (x) represents a timer counting down in seconds. This display is for administrator mode only. Do not press a key during this time, and **No change** is selected automatically.

Note: *If you press a key accidentally, please contact your system administrator.*

Now the display shows:

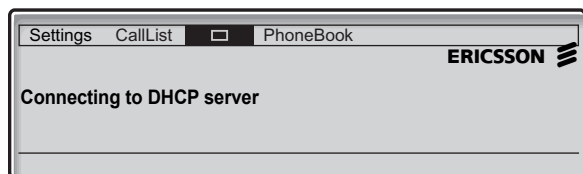

The IP telephone is connecting to the DHCP server and gets its IP address from the network.

Note: *This menu is not displayed if you are using fixed IP addresses.*

After the IP address has been retrieved, the telephone checks automatically if new software is available. See section "[Software updates](#)" on page 88.

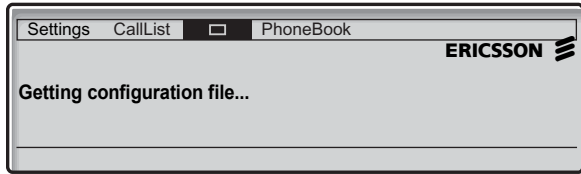

In case of no available software updates, the display changes to:

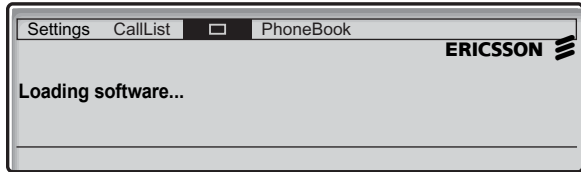

Now the software is loaded internally in the telephone. This takes about 15 seconds, no further action is necessary. When the software loading has been completed, the telephone will perform a self test:

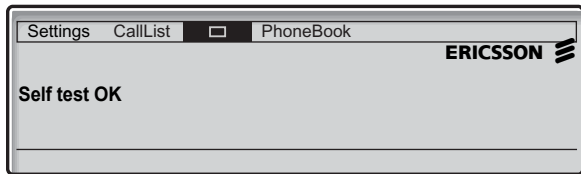

Now the telephone is ready to use, and you have to log on to the network. See section [“Log On / Log Off”](#) on page 15.

Software updates

If a new software for your IP telephone is available, the following display will appear after retrieving the IP address:

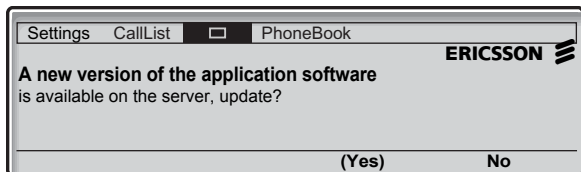

The x indicates a timer counting down seconds.

(Yes) **Press to start the software update.**

Note: *If you do not press any key, <Y> is selected automatically.*

Or:

No **Press to use the current software version.**

The software update is cancelled and the normal start up procedure will continue.

If you decided to update your telephone software, the following display will appear:

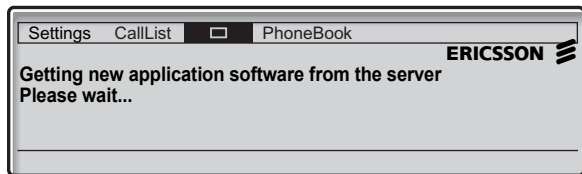

The software is loaded from the server. This will take about 30 seconds. When the software download is complete, the display changes to:

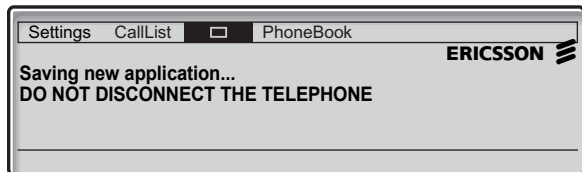

It is important that you do not disconnect the telephone's power supply while this text is displayed. The saving of the new application takes about 30 seconds. If a power failure occurs during this phase, the telephone must load the software again.

Software version

You can check the software version of your telephone:

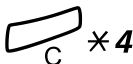

Press simultaneously for at least one second.

The program version is displayed for 5 seconds, and then all available characters are displayed for a minute.

Press to return to idle mode.

Install cables

Handset cable to the left

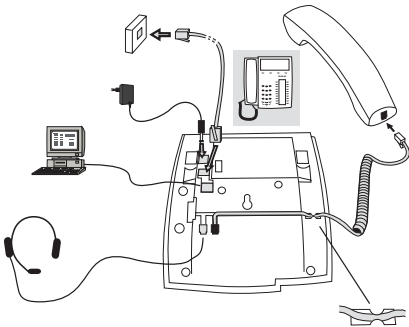

Handset cable to the right

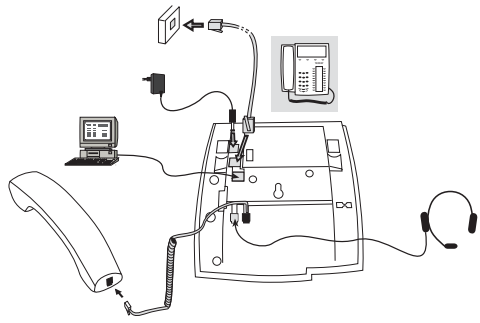

You can put the cable to the handset in the notch underneath the telephone. The cable to the exchange has to be plugged in LINE and the handset cable has to be plugged in HANDSET.

Note: The installation of the 24 V power adapter is optional. If no external power supply has been installed, the telephone will rely on the LAN power supply.

Change cables

To remove a cable, use a screwdriver to unlock the stop.

Install stand and adjust telephone

Position high

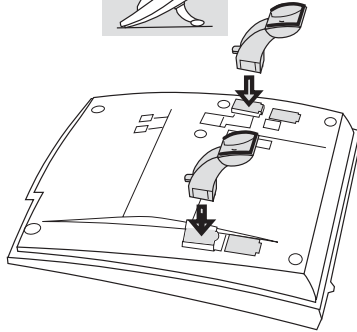

Position low

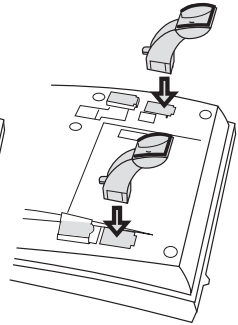

Press to fasten stand

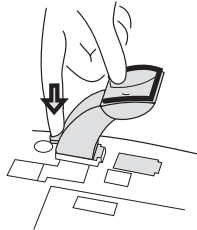

Release to remove stand

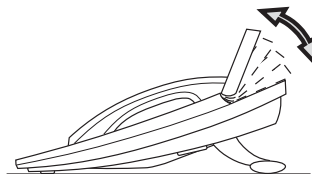
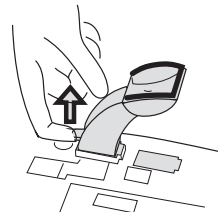

Tiltable display

Adjustable angle

Install pullout leaf

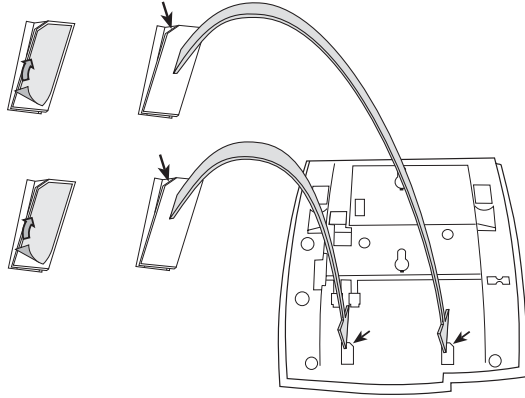

- 1 Remove the protective film from the guiding rails.**
- 2 Attach the guiding rails to the bottom of the phone, observing the direction of the “cut” corner.**

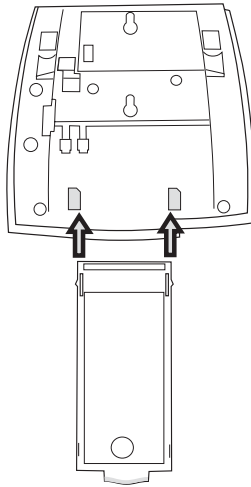

- 3 Insert the pullout leaf.**

Wall mounting handset hook

The phone can be wall mounted without using a special console. Useful for instance in conference rooms or public areas.

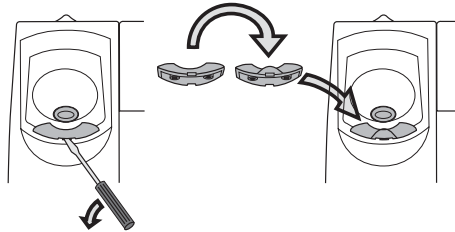

- 1 Use a screwdriver to remove the handset hook.**
- 2 Turn the hook upside down and insert.**

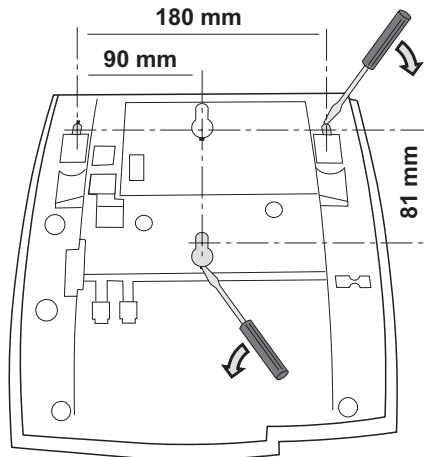

- 3 Use a screwdriver to remove the two plastic covers.**
- 4 Drill wall holes according to measure.**

Spacer, alternative 1
(recommended)

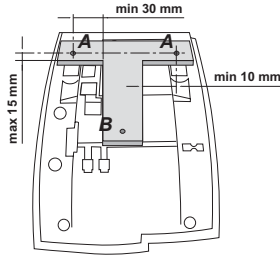

Spacer, alternative 2

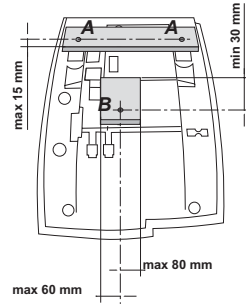

Two **upper** wall distance screws
and spacer(s) measures

Lower wall distance screw
and spacer measures

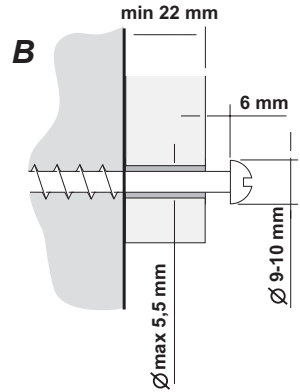
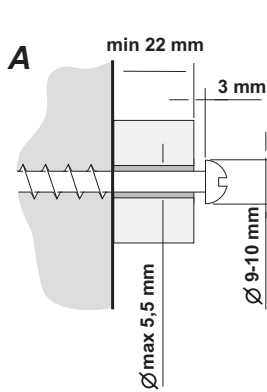

5 Mount screws according to measures and attach the phone.

Install card

Use the Designation Card Manager to make and print your own designation cards. The Designation Card Manager is included on the Ericsson Telephone Toolbox CD. For questions regarding the product, please contact your Ericsson Enterprise Certified Sales Partner.

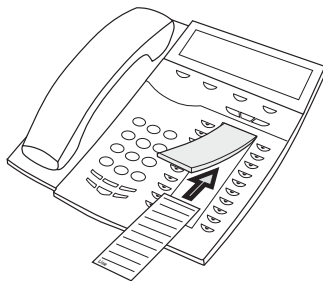

Placing the telephone

- Do not place your telephone on sensitive surfaces. Use a non-slippery pad to protect your furniture from possible damage.
- Do not place your telephone near sources of extreme heat, e.g. near the radiator.
- Make sure that the line cable isn't creased.

Cleaning the telephone

Use a slightly moistened (not wet) soft cloth or an anti-static cloth and wipe off the telephone carefully. Do not use rough cloth, solvents or aggressive cleaning fluids. Any damages of the telephone, that are caused by non-observance of these instructions, are not part of the liability given by the manufacturer.

Troubleshooting

This section contains information on how to solve common operational problems. Go through the following steps if you encounter any problems. If this does not solve the problem, contact your system administrator. If others have similar problems, there may be a system error.

Fault check list

1. Read the Installation chapter.

To make sure that you have done everything correctly and that everything is properly connected.

2. Disconnect all extra equipment.

If your telephone is working properly when done, the problem lies in the extra equipment.

3. Connect a functioning telephone instead of the faulty one.

If that telephone is working properly, the problem is probably in your telephone, contact your system administrator.

4. Check for operational problems.

If operational problems are found, the problem is in the telephone network, contact the local telephone service or the local telephone company.

5. Reboot the telephone.

Press and hold for at least one second.



Glossary

Abbreviated Number Dialling

Initiating a call to a pre-programmed number by dialling a code or pressing a key. There are common short-numbers, which means that all extensions can use them. See section “[Abbreviated Numbers](#)” on page 24.

Account Number

To place call costs on an Account Number. See section “[Other Useful Features](#)” on page 64.

Automated Attendant

A facility which sends voice instructions to internal and external callers, providing all options which can be chosen. Voice instructions lead the caller to the desired destination. See section “[Other Useful Features](#)” on page 64.

Callback

An indication to a busy extension, to inform the person that you want to speak to him/her. See sections “[Messages](#)” on page 50 and “[Outgoing Calls](#)” on page 20.

Camp-on

To place (queue) a call to a busy extension. See section “[Outgoing Calls](#)” on page 20.

Dial-by-Name

Initiation of a call by operating a single key. Internal numbers (or Common Abbreviated Numbers) can be stored on each extension. See section “[Abbreviated Numbers](#)” on page 24.

Directory number

Numbers with 1 – 8 digits which are assigned to extensions or external lines or as Common Abbreviated Numbers.

Direct Inward System Access (DISA)

If you are working externally, the DISA function enables you to make external calls (long distance) via the company PBX. You only pay for the call to your company. See section “[Other Useful Features](#)” on page 64.

Diversion

Incoming calls to an extension are diverted to another directory number (extension, common abbreviated number or the operator). There are three possibilities:

1. *Direct, which means that all calls to an extension are forwarded directly.*
2. *On no reply, which means that a call is forwarded if it is not answered within a certain time.*
3. *On busy, which means that a call is forwarded if the extension is busy.*

See section “[Call Forwarding](#)” on page 41.

Diversion Bypass

This is useful for letting urgent calls through to an extension where diversion is active. See section “[Call Forwarding](#)” on page 41.

Extension

All telephones connected to the PBX have a unique internal number (up to 3 digits).

Information

Internal callers are informed about absence and time of return. External callers are diverted to the operator, where the same information is available. Information can be of two kinds:

1. *Pre-programmed text information.*
2. *Voice information.*

Intrusion

To intrude on an ongoing call when a requested extension is busy. See section “[Outgoing Calls](#)” on page 20.

Least Cost Routing

A function that automatically selects the cheapest way to connect your external call (not necessarily the shortest distance).

Mailbox

The mailbox system controls the messages that are left for or sent by you when you are absent. See section “[Individual Mailbox system](#)” on page 51.

Message

A message can be sent to any extension. This is useful when you receive the busy tone or get no answer. There are two kinds of message:

1. *Call Me message.*
2. *Voice message.*

See section “[Messages](#)” on page 50.

Mute

To switch the microphone temporarily off. See section “[During Calls](#)” on page 36.

Password (System)

A four-digit code needed to e.g. block your extension and retrieve messages from the mailbox system. You can set your own Password. See section “[Security](#)” on page 58.

PBX

Private Branch Exchange. Your telephone switching system (e.g. BusinessPhone 250).

Pre-defined text

Pre-programmed absent information. See section “[Absence Information](#)” on page 46.

Third party

A third connection (person), which can be included in an ongoing two person conversation. The connection can be internal or external. See section “[During Calls](#)” on page 36.

Tie line

An external line from the private network.

Transfer

During an internal or external ongoing call you can make an inquiry and then transfer the call to another party (internal or external). See section “[During Calls](#)” on page 36 and “[Useful Hints](#)” on page 86.

Trunk line

A trunk line is the same as an external line. Can be either digital or analog.

Index

A

- Abbreviated Numbers 24
- Absence Information 46
 - Change information 49
 - Enter information 47
- Accessories 83
- Account Number 68
- Alternative programming for Automatic Callback, Camp-on, Intrusion 82
- Answer a second call 18
- Answer calls 17
- Automatic Callback 22

B

- Block extension 60
- Busy extension 22
- Bypass blocked extension 59

C

- Call Forwarding 41
 - Diversion when there is no answer 41
 - Fixed Diversion 42
 - Follow-me 44
 - Individual Diversion 42
- Call List 32
 - Missed/Rejected calls 33
 - Redial 32
- Call Waiting 39
- Camp-on 22
- Change information 49
- Change Password 58
- Check and store received messages 54
- Cleaning the telephone 95
- Common Abbreviated Numbers 24
- Common Hold 40
- Conference 39

D

- Description
 - Display info 9
 - Ericsson Dialog 4425 IP Vision 6
 - Lamp indications 8
 - Menu Structure 12
 - Signals 14
 - Tones 13
- Dial-by-Name 24
- Dialog 4425 IP Vision 6
- Dictaphone function 57
- Direct Inward System Access (DISA) 67
- Display info 9
- Diversion when there is no answer 41
- Diverted Extension 23
- Doorphone 66
- DTMF Tones 68
- During Calls 36
 - Call Waiting 39
 - Common Hold 40
 - Conference 39
 - From handset to handsfree 36
 - From handsfree to handset 37
 - Group Listening 36
 - Individual Hold 40
 - Inquiry 37
 - Mute 37
 - Transfer 38

E

- Erase information 49

F

- Fault check list 96
- Fixed Diversion 42
- Follow-me 44
- Forward a Voice message 55
- From handset to handsfree 36
- From handsfree to handset 37

G

- Glossary 97
- Group Call-pick-up 61
- Group Features 61
 - Group Call- pick-up 61
 - Group Hunting 62
- Group Hunting 62
- Group Listening 36

H

- Handset and loudspeaker volume 74
- Hearing aid compatibility 76

I

- Incoming Calls 17
 - Answer calls 17
 - Handsfree 17
 - Silent Ringing 19
- Individual Diversion 42
- Individual Hold 40
- Individual Mailbox system 51
- Inquiry 37
- Install cables 90
- Installation 87
 - Adjust telephone 91
 - Cables 90
 - Card 95
 - Cleaning the telephone 95
 - Placing the telephone 95
 - Pullout leaf 92
 - Stand 91
 - Wall mounting handset hook 93
- Intrusion 23

L

- Lamp indications 8
- Language 79
- Last External Number Redial 21
- LCR 69
- Least Cost Routing 69
- Log off 16
- Log on 15
- Log On / Log Off 15

M

- Make calls 20
- Menu Structure 12
- Messages 50
 - Check and store received messages 54
 - Dictaphone function 57

- Forward a Voice message 55
- Individual Mailbox system 51
- Outcall (External) Notification 53
- Password protection 50
- Personal Greeting 51
- Send Message 56
- Missed/Rejected calls 33
- Mute 37

N

- Network Settings 80

O

- Other Useful Features 64
 - Account Number 68
 - Direct Inward System Access (DISA) 67
 - Doorphone 66
 - DTMF Tones 68
 - Least Cost Routing 69
 - Reminder 65
 - Tandem configuration 64
- Outcall (External) Notification 53
- Outgoing Calls 20
 - Abbreviated Numbers 24
 - Automatic Callback 22
 - Busy extension 22
 - Common Abbreviated Numbers 24
 - Dial-by-Name 24
 - Diverted Extension 23
 - Handsfree 21
 - Last External Number Redial 21
 - Make calls 20

P

- Personal Greeting 51
- Phone book 26
- Placing the telephone 95

R

- Redial from Call List 32
- Reminder 65
- Ringling signal character 75

S

- Save information 49
- Security 58
 - Block extension 60
 - Bypass blocked extension 59
 - Change Password 58
- Send Message 56

- Settings 72
 - Handset and loudspeaker volume 74
 - Hearing aid compatibility 76
 - Language 79
 - Network Settings 80
 - Ringing signal character 75
 - Time and Date 77
- Signals 14
- Silent Ringing 19
- T**
 - Tandem configuration 64
 - Time and Date 77
 - Tones 13
- Transfer 38
- Troubleshooting 96
 - Fault check list 96
- U**
 - Useful Hints 86
- V**
 - Volume 74
- W**
 - Welcome 4
 - Write Text 70



Log on / Log off

Log on: *Ext. No.* **Log on**
Password **Log on**

Log off: **Log off** **Yes**

Answer calls

Answer: *Lift handset*

Handsfree: **Line**  or 

Answer on another ext.: *Ext. No.* **6**

Make calls

Internal calls: *Ext. No.*

External calls: **0** *External No.*

Common *Abbreviated No.*

Abbreviated Number:

Last External *** * ***

Number Redial:

You get busy tone or no answer

Automatic Callback: **5** *Replace handset*
Lift handset when called back

Camp-on: **4** *Keep handset off hook*

Intrusion: **8**

During calls

Switch to handsfree:  *Replace handset*

Switch to handset: *Lift handset*

Group listening: 

Inquiry



Ongoing conversation: **Line**  *Call 3rd party*

Refer Back

Switch between calls: **Line**  **2**

To terminate: **Line**  **1**

Conference

Ongoing conversation: **Line**  *Call 3rd party*
Line  **3** *(To establish)*
Replace handset (To leave)

Transfer

Transfer a call: **Line**  *Call 3rd party*
Replace handset
(Before or after answer)

Messages

Call Me: **9 #**

Voice: **99** *Speak*
Play-back: *****
Re-record: **9** *Speak*
Send: **#**

Receive messages: *Lift handset* *** 59 #**

Call Forwarding

Fixed Diversion: *** 21 #**

Internal Diversion: *** 21 ***
New No. #

Cancel: **# 21 #**

Follow-me: *** 21 ***
*Own No. * New No. #*

Cancel: **# 21 #**
Own No. #

Bypass Call Forwarding: *** 60 ***
Ext. No. #

External Diversion:
Program: *** 22 ***
Line access code
External No. #

Cancel: **# 22 #**

Re-activate: *** 22 * #**

Ericsson is shaping the future of Mobile and Broadband Internet communications through its continuous technology leadership. Providing innovative solutions in more than 140 countries, Ericsson is helping to create the most powerful communication companies in the world.

All rights reserved.
Ericsson Enterprise AB
For questions regarding the product,
please contact your Ericsson Enterprise Certified Sales Partner.
Also visit us on www.ericsson.com/enterprise

© Ericsson Enterprise AB 2003
EN/LZTBS 160 1345 R1A

