

# Dialog 4223 Professional / Dialog 3213

BusinessPhone Communication Platform

## User Guide



EN/LZTBS 160 1322 R1A  
© Ericsson Enterprise AB 2003

# Table of Contents

	page
Welcome .....	4
Description .....	6
Incoming Calls .....	18
Outgoing Calls .....	21
Phone Book .....	32
During Calls .....	33
Call Metering .....	38
Call Forwarding .....	45
Absence Information .....	51
Messages .....	56
Security .....	71
Group Features .....	74
ISDN Facilities .....	79
Other Useful Features .....	86
Write Text .....	95
Settings .....	96
Accessories .....	105
Useful Hints .....	111
Glossary .....	112
Installation .....	115
Index .....	126
Quick Reference Guide .....	131

# Welcome

Welcome to the User Guide for the Dialog 4223 Professional / Dialog 3213 in the BusinessPhone Communication Platform from Ericsson. The BusinessPhone Communication Platform consists of BusinessPhone 50, BusinessPhone 128i and BusinessPhone 250.

The features described in this User Guide are related to version 5.1 or higher of the BusinessPhone Communication Platform. Some might not work in earlier versions of the system and/or might be protected by a hardware dongle that has to be bought separately.

The User Guide describes the facilities of the BusinessPhone Communication Platform and the Dialog 4223 Professional / Dialog 3213 with a default programming. There may be some differences in the way your phone is programmed. Please consult your system administrator if you need further information.

The latest version of this User Guide can also be downloaded from: <http://www.ericsson.com/enterprise/>

**Note:** *Dialog 4223 Professional / Dialog 3213 is a system telephone, i.e. it can only be used for an Ericsson private branch exchange that supports this type of telephone.*

Function descriptions that do not include speaking in the handset, are described as off-hook, if nothing else is stated. Instead of pressing the Clear key, you can always replace the handset. The Dual-Function keys allow two functions to be combined on the same keys.

## Copyright

All rights reserved. No parts of this publication may be reproduced, stored in retrieval systems, or transmitted in any form or by any means, electronic, mechanical, photocopying, recording or otherwise, without prior written permission of the publisher except in accordance with the following terms.

If this publication is made available on Ericsson media, Ericsson gives its consent to downloading and printing copies of the content provided in this file only for private use and not for redistribution. No parts of this publication may be subject to alteration, modification or commercial use. Ericsson will not be liable for any damages arising from use of an illegal modified or altered publication.

---

## Warranty

ERICSSON MAKES NO WARRANTY OF ANY KIND WITH REGARD TO THIS MATERIAL, INCLUDING, BUT NOT LIMITED TO, THE IMPLIED WARRANTIES OF MERCHANTABILITY AND FITNESS FOR A PARTICULAR PURPOSE. Ericsson shall not be liable for errors contained herein nor for incidental or consequential damages in connection with the furnishing, performance or use of this material.

---

## Declaration of Conformity

*Hereby, Ericsson Enterprise AB, S-131 89 Stockholm, declares that this telephone is in conformity with the essential requirements and other relevant provisions of the R&TTE directive 1999/5/EC.*

Details to be found at:

<http://www.ericsson.com/sdoc>

# Description

## Dialog 4223 Professional

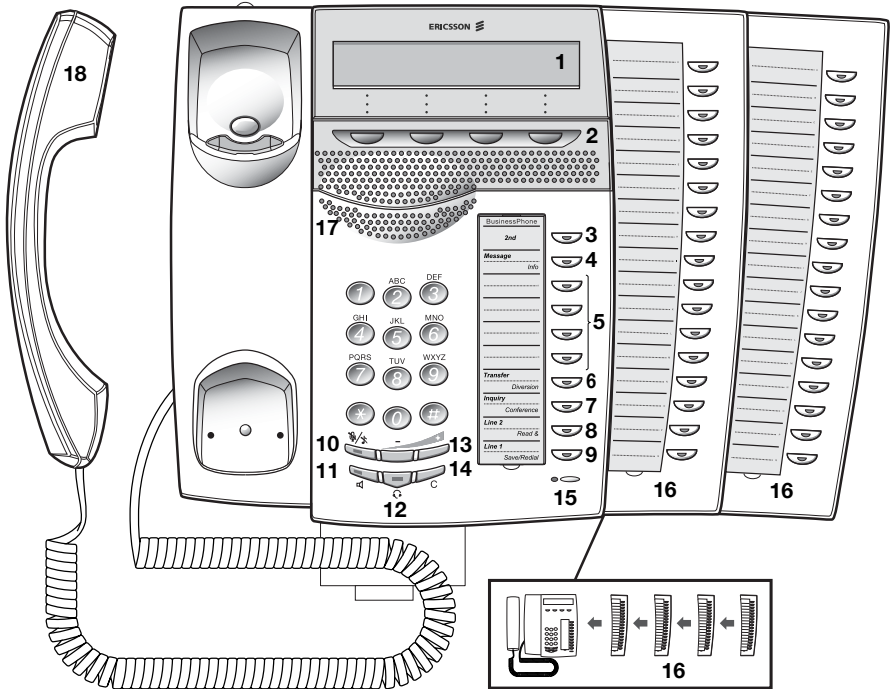

- 1 Display**  
3x40 characters. See section “[Display info](#)” on page 14.
- 2 Menu Function keys**  
The functions depend on the traffic state and will be shown on the last line of the display. When you are requested to (**see display**), press the required key to access the function.
- 3 2nd**  
Key for access to secondary key functions (these functions are stated on the second line of the corresponding key).
- 4 Message / Info**
  - a. To send and receive messages. See section “[Messages](#)” on page 56.
  - b. To enter information. See section “[Absence Information](#)” on page 51.
- 5 Dual-Function programmable keys**  
Storing numbers, program functions. See section “[Settings](#)” on page 96.
- 6 Transfer / Diversion**
  - a. Transfer an ongoing call. See section “[During Calls](#)” on page 33.
  - b. Activate/Deactivate diversion. See section “[Call Forwarding](#)” on page 45.
- 7 Inquiry / Conference**
  - a. To make an inquiry to an internal or external party.
  - b. To establish a telephone conference.  
See section “[During Calls](#)” on page 33.
- 8 Line 2 / Read &**
  - a. Line key 2 for in and outgoing calls.
  - b. Read information. See section “[Absence Information](#)” on page 51.
- 9 Line 1 / Save/Redial**
  - a. Line key 1 for in and outgoing calls.
  - b. Save or redial an external number. See section “[Outgoing Calls](#)” on page 21.
- 10 Mute**  
To switch the microphone on or off. See sections “[During Calls](#)” on page 33 and “[Silent Ringing](#)” on page 20.
- 11 Loudspeaker on/off**  
To switch the loudspeaker on or off. See section “[During Calls](#)” on page 33.

- 12 Headset**  
See section “[Headset - Dialog 4223 Professional](#)” on page 107.
- 13 Volume control**  
To adjust the volume. Also space/backspace in writing mode.
- 14 Clear**  
To disconnect calls or to clear the display in programming.
- 15 Microphone**
- 16 Optional key panel**  
17 Dual-Function programmable keys per key panel. Four panels can be connected.  
  
**Note:** *Use only optional key panels of type DBY 419 01.*
- 17 Loudspeaker**
- 18 Handset with hearing aid function**  
  
**Please note:** *The handset may attract and retain small metal objects in the earcap region.*

## Dialog 3213 Executive

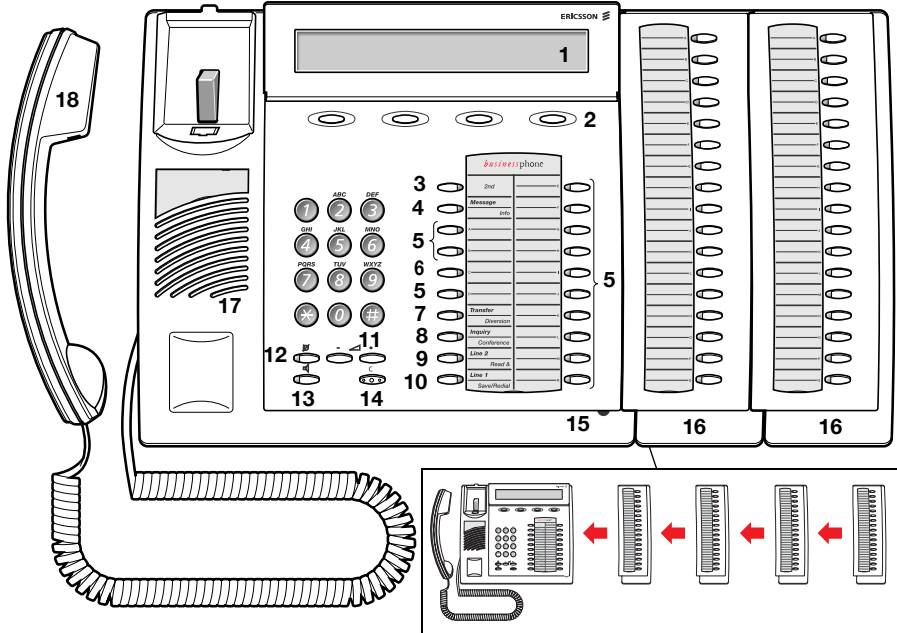













- 1 Display**  
3x40 characters. See section “[Display info](#)” on page 14.
- 2 Menu Function keys**  
The functions depend on the traffic state and will be shown on the last line of the display. When you are requested to **(see display)**, press the required key to access the function.
- 3 2nd**  
Key for access to secondary key functions (these functions are stated on the second line of the corresponding key).
- 4 Message / Info**
  - a. To send and receive messages. See section “[Messages](#)” on page 56.
  - b. To enter information. See section “[Absence Information](#)” on page 51.
- 5 Dual-Function programmable keys (A-N)**  
Storing numbers, program functions. See section “[Settings](#)” on page 96.
- 6 Dual-Function programmable key (C) / Headset key**
  - a. Storing numbers and program functions.
  - b. The Headset function is only available with option unit (DBY 410 02) installed. The Headset key is programmed by the system administrator. See section “[Accessories](#)” on page 105.
- 7 Transfer / Diversion**
  - a. Transfer an ongoing call. See section “[During Calls](#)” on page 33.
  - b. Activate/Deactivate diversion. See section “[Call Forwarding](#)” on page 45.
- 8 Inquiry / Conference**
  - a. To make an inquiry to an internal or external party.
  - b. To establish a telephone conference.  
See section “[During Calls](#)” on page 33.
- 9 Line 2 / Read &**
  - a. Line key 2 for in and outgoing calls.
  - b. Read information. See section “[Absence Information](#)” on page 51.
- 10 Line 1 / Save/Redial**
  - a. Line key 1 for in and outgoing calls.
  - b. Save or redial an external number. See section “[Outgoing Calls](#)” on page 21.
- 11 Volume control**  
To adjust the volume. Also space/backspace in writing mode.

- 12 Mute**  
To switch the microphone on or off. See section “[During Calls](#)” on page 33.
- 13 Loudspeaker on/off**  
To switch the loudspeaker on or off. See section “[During Calls](#)” on page 33.
- 14 Clear**  
To disconnect calls or to clear the display in programming.
- 15 Microphone**
- 16 Optional key panel (A-Q)**  
17 Dual-Function programmable keys per key panel. Four panels can be connected.
- Note:** If one or two key panels are used, the optional key panel DBY 409 01 may be used. However, if three or four key panels are used, all optional key panels must be of type DBY 409 02.*
- 17 Loudspeaker**
- 18 Handset with hearing aid function**
- Please note:** The handset may attract and retain small metal objects in the earcap region.*

## Phone keys Dialog 4223 / Dialog 3213

This table gives you an overview of the different key design of the Dialog 4223 Professional and the Dialog 3213 Executive. In this user guide you will only find illustrations of the Dialog 4223 keys.

If you are using the Dialog 3213 Executive, please refer to the table below to find out the appropriate key combination.

Key	Dialog 4223	Dialog 3213
Clear		
Headset		Headset 
Loudspeaker		
Mute		
Programmable Function key		
Volume		

## Lamp indications

The key lamps on your telephone indicate with different signals the traffic state of the ongoing call or function.



Extinguished lamp

The function is not active.



Steady light

The function is active.



Slowly flashing lamp

The line (or function) is put on hold.



Rapidly flashing lamp

An incoming call or message waiting.



Light with short breaks

Ongoing call.

## Display info

The display assists your actions on the phone with step-by-step instructions. When your phone is idle, the upper line shows general information. The mid line shows your name and extension number. The lower line presents lead texts for the menu keys.

```
12 May 10:35 +15°  
ANDERSEN ANDREAS      200  
directory              redial      Prog
```

During an internal call the middle line shows the other party's name, extension number and status.

```
12 May 10:35 +15°  
BURNES BOBBY          201  SPEECH
```

If you make an internal call to someone who has activated a diversion, the first line shows the name and extension number of the person you called and the middle line shows where the call is diverted.

```
DAVID CHAMBERS        203  
BURNES BOBBY          201  FREE  
                        call-back
```

During an incoming external call the middle line shows the other party's number and status (if connected to an ISDN-trunk line).

```
12 May 10:35 +15°  
                        431811005446  SPEECH  
                        save
```

**Status information**

Status information during internal calls:

BLOCKED	The called number is blocked.
BUSY	The called extension is busy.
CALLING	Incoming call.
CONFERENCE	Conference.
CONGEST	Congestion in the system.
DISPLAY RESTRICTED	ISDN call, Number Secrecy is activated on the called/calling extension.
FREE	The called extension is free.
FREE L2	The called extension is free on Line 2.
INCOMPLETE	The number was incomplete.
INTRUSION	Intrusion.
NOT ALLOWED TO PICK UP FROM COB	Not allowed to pick-up incoming calls from the Common Bell.
PARKED	The called extension has put a call on hold.
PARKED CALL	A call is put on hold.
RECALL	Recall from an individually call that has been put on hold.
SPEECH	Speech mode.
UNAVAILABLE	The dialled number is unavailable.
UNKNOWN	Number unknown.
WAIT	Camp-on mode.
&	The called extension has Text info stored.
%	The called extension has Voice info stored.
+15*^	Indicates outside temperature and tendency (up or down) if your telephone system is equipped with optional temperature sensor.

# Tones

Tones are audible in the handset.

## Dial tone

(System ready to accept digits)



## Special dial tone

(System ready to accept digits, active diversion on telephone)



## Ringing tone

(Ringing signal to called party)



## Special ringing tone

(Ringing signal to Line 2)



## Busy tone

(Called party is busy)



## Number unobtainable tone

(Called number not accessible or vacant)



## Call Waiting tone



## Blocking tone

(Call cannot be executed due to congestion or called party blocked)



## Verification tone

(Verification that ordered function is accessed)



## Intrusion tone

(Sent to all parties during Intrusion)



## Conference tone

(Sent to all participants in a Conference)

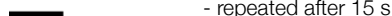

## Signals

Ringing signals are emitted from the phone.

**Internal ringing signal**



- repeated after 4 s

**External ringing signal**



- repeated after 4 s

**Automatic Callback signal**



**Note:** *The tones and ringing signals in this guide refer to the standard system but may vary between countries.*

# Incoming Calls

## Internal calls

A ringing signal and a flashing lamp indicate an incoming call. The display shows the number and the name of the internal caller.

---

## External calls

A ringing signal and a flashing lamp indicate an incoming call. If you are connected to a digital trunk line (ISDN), the display shows the number of the external caller and in case of diversion in the public net the display shows the number of the diverted as well as the calling party, see also section “[ISDN Facilities](#)” on page 79. A trunk line is the same as an external line.

---

## Answer calls



**Lift the handset.**

### Handsfree



**Press without lifting handset.**

**Or:**



**Press without lifting handset.**

You are connected to the caller via the loudspeaker and microphone.



**Press to terminate a handsfree call.**

**On another extension**

You can answer a call to another extension from any phone in your office.

**Call the ringing extension.**

You receive busy tone.

```

12 May 10:35 +15°
ANDERSEN ANDREAS      200 BUSY
  CAMP-ON call-back  pick-up intrusion
  
```

Pick-up

Press (see display).

**Allow calls on Line 2**

If you also want to receive calls also while speaking you first need to program Free On 2nd Access on a programmable key. See section “Settings” on page 96.

Free On 2nd  
Access

**Press to activate / deactivate Free On 2nd Access (pre-programmed).**

When Free On 2nd Access is active the lamp lights and you can receive calls while speaking.

**Answer a second call**

You are on the phone, when a muted ringing signal and a Line key flashes to indicate a new incoming call:

Line 2 

**Press the flashing Line key.**

The first call is put on hold.

**Note:** If you want to see who is calling, first press L2-info (see display).

To switch back to the first call:

Line 1 

**Press the first Line key.**

The second call is put on hold. You are connected to the first caller.



Press if you want to terminate the ongoing call.

## Silent Ringing

This function is useful if you do not want to be disturbed by the ringing of the telephone. Incoming calls will only be indicated on the display and by the flashing Line key.

**Note:** For the Dialog 3213 this function requires the release number R9B or higher, see the underside of your telephone.



In idle mode:

**Press to mute the ringer for incoming calls.**

---

## Save and redial incoming calls

When you receive an incoming external call, you can save the number in order to redial it easily (the number can contain 24 digits maximum). Previously saved number is erased.

### Save number

Before you quit the call:

save

**Press (see display).**

### Redial number

redial

**Press to redial the saved number (see display).**

# Outgoing Calls

Sometimes you make a call but the person is not available. These functions will help you in your attempts to establish contact with the called party.

---

## Make calls

How to make internal and external calls.



**Lift the handset and dial either:**



**An extension number to make an internal call.**

**Or:**



**The digit(s) for external call access and the external number.**

***Note:** Which digit to press for external call access, depends on the configuration of the system.*

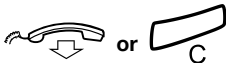

**Press to end the call.**

***Note:** You can make your calls faster, using Common Abbreviated Numbers and by programming your own Abbreviated Numbers.*

### Handsfree

Without lifting the handset, just press a Line key, or the Loudspeaker key, or the first digit of the number. The call is in handsfree mode, via the loudspeaker and microphone.

## Last External Number Redial

When you initiate an external call the system automatically stores all the dialled digits, irrespective of whether the call was successful or not. See also section “[Automatic Redial](#)” on page 24.

✳✳✳

**Press to redial the last dialled external number.**

The display will show the dialled number.

---

## Save external number

When you make an external call, you can save the number in order to redial it easily. Previously saved number is erased.

### Save number

Before you quit the call:

save

**Press (see display).**

### Redial number

redial

**Press to redial the saved number (see display).**

## Automatic Callback

You call an extension and receive busy tone or get no answer.

```

12 May 10:35 +15°
BURNES BOBBY          201 BUSY
camp-on call-back      intrusion
  
```

call-back

**Press (see display).**

Verification tone.

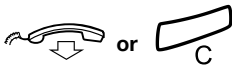

**Replace the handset or press to finish the procedure.**

You are called back if the extension finishes the ongoing call or the next time the extension finishes a new call. You have to answer within eight seconds otherwise the Callback service is cancelled.



**Lift the handset when you are called back.**

(You can also press the Line or Loudspeaker key to answer in handsfree mode.)

## Automatic Redial

If you call an external number and receive busy tone or get no answer, you can instruct the system to automatically redial the number until it is available.

**Note:** *This feature could be restricted. Ask the system administrator for the availability.*

This function is activated via Function keys, so you first have to program a programmable key (one key required per number). See section “[Program a function](#)” on page 97. You can activate Automatic Redial on up to five external numbers at the same time.

### Activate

During the call:

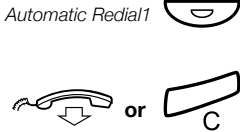

#### **Press to activate (pre-programmed).**

The Automatic Redial lamp is rapidly flashing and is lit when the request is stored and activated. Verification tone.

#### **Replace the handset or press to finish the procedure.**

You are called back if the called number finishes the ongoing call or the next time the extension finishes a new call. The display shows:



#### **Lift the handset when you are called back.**

(You can also press the Line or Loudspeaker key to answer in handsfree mode.)

**Notes:**

*It is not possible to do a new request on a key holding an already activated request until the existing one is cancelled.*

*When the Automatic Redial lamp is rapidly flashing, your telephone is busy and you cannot receive or make new calls.*

*The number of redial attempts and how long the function is active is programmed by your system administrator.*

*If you have activated a diversion on your telephone, this function is not available.*

*If Tandem configuration is activated, the secondary telephone cannot use this function. See section "[Tandem configuration](#)" on page 86.*

**Cancel**

Automatic Redial1



**Press the relevant programmable key to cancel the Automatic Redial request (pre-programmed).**

**Note:** *Depending on system programming, the Automatic Redial request could be cancelled automatically.*

**Pause**

It is possible to pause all of your successfully activated requests by programming a separate Pause Auto Redial key, see section "[Program a function](#)" on page 97.

Pause Auto Redial



**Press to pause (pre-programmed).**

The requests are paused and the key lamps of the Automatic Redial keys are flashing slowly.

Pause Auto Redial



**Press to resume Automatic Redial (pre-programmed).**

## Busy extension

You call an extension and receive busy tone.

### Camp-on

You can notify a busy extension of your call by a muted ringing call.

CAMP-ON

#### **Press (see display).**

Keep the handset off hook. When the called extension replaces the handset, it will be called automatically.

**Note:** *If you receive the busy tone again, the desired extension does not allow Camp-on.*

### Intrusion

You can intrude on an ongoing call on a busy extension (if this function is allowed).

intrusion

#### **Press (see display).**

Intrusion tone is heard and a three-party call is established. When the called extension replaces the handset and you keep off hook, the called extension will be recalled automatically.

**Note:** *If you still hear the busy tone, your extension does not have the authority to intrude or the desired extension is protected against Intrusion.*

## Diverted extension

Bypass Call Forwarding makes it possible to call a specific extension, even if Call Forwarding is activated on this extension.

✖ 6 0 ✖



**Dial.**

**Enter extension number.**

#

**Press.**

You will be connected to the specified extension, regardless of which type of call forwarding the called extension has activated.

## Abbreviated Numbers

By using Abbreviated Numbers, you can make calls simply by pressing a few keys. Frequently used external numbers are stored as Common Abbreviated Numbers in the exchange.

Your personal most frequently used external numbers - called Individual Abbreviated Numbers - can be stored and used on the 2nd layer of the programmable keys on the telephone, on the key panels, or on the keys 0 to 9 (Dialog 4223 Professional).

**Note:** Functions that you activate/deactivate via a dial code, e.g. \*32\* and #32# for Reminder, can also be stored as Individual Abbreviated Numbers.

You have two options to program an Individual Abbreviated Number or a function:

### Option 1 - Via a programmable key

Individual Abbreviated Numbers can be programmed on the programmable keys and on the optional key panels. See section "[Individual Abbreviated Numbers via a programmable key](#)" on page 29.

### **Option 2 - Via the keypad**

If you are using the Dialog 4223 Professional without a key panel, you can program 10 Individual Abbreviated Numbers on the keys 0 to 9. Additionally, you can program the programmable keys on the telephone (see Option 1). See section “[Individual Abbreviated Numbers via the keypad](#)” on page 30.

**Note:** *If you are upgrading your Dialog 4223 Professional with an optional key panel, all Abbreviated Numbers that are programmed via the keypad on the keys 0 to 9, will be stored on the first 10 programmable keys on the first key panel automatically.*

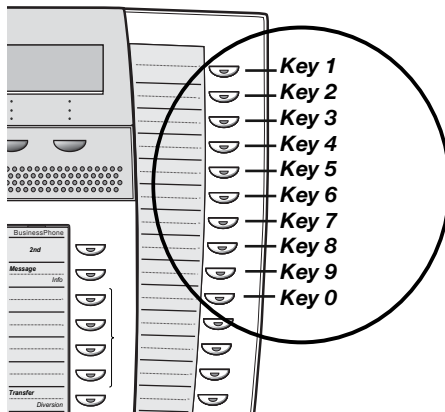

## **Common Abbreviated Numbers**

External numbers are stored centrally in your BusinessPhone Communication Platform. Common Abbreviated Numbers can be dialled from every extension that has the authority to do so.



### **Dial the Common Abbreviated Number.**

Please refer to your telephone directory.

## Individual Abbreviated Numbers via a programmable key

You can program and activate your most frequently used external numbers on the 2nd layer of a programmable key. This procedure can also be used if you want to program a function that is activated/deactivated via a dial code.

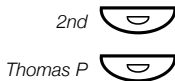

**Press.**

**Press to make a call or activate a dial code (pre-programmed).**

### Program Individual Abbreviated Number

How to program external numbers or dial codes on the programmable keys on the telephone and on the key panel.

PROG

**Press (see display).**

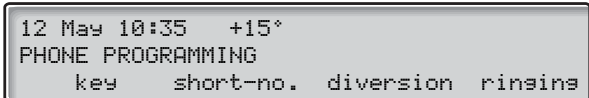

short-no.

**Press (see display).**

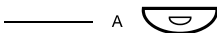

**Press a programmable key.**



**Dial the digit(s) for external call access and dial the number.**

Which digit to press for external call access, depends on the configuration of the system. The number can consist of up to 24 digits.

*Note: If your public network requires waiting for a second dial tone, press the key 2nd followed by the key 2.*



**Or:**

**Dial a code (2 digits).**

store

**Press to store the number or the code (see display).**



**Press to finish programming.**

**Note:** The Dual-Function keys allow Individual Abbreviated Numbers and other functions e.g. Dial-by-Name to be combined on the same keys. You can remove the transparent cover in order to write the names beside the keys. Put the name referring to the Individual Abbreviated Number in the field below the line to indicate that it is the secondary function.

---

## Individual Abbreviated Numbers via the keypad

You can program and activate your most frequently used external numbers via the keypad.



**Press and dial the Abbreviated Number.**

A number between 0 and 9.

### Program Individual Abbreviated Number

How to program external numbers on the keys 0 to 9.

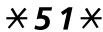

**Enter Programming mode.**



**Select an Abbreviated Number between 0 and 9 and press.**



**Dial the digit(s) for external call access and dial the number.**

The number can consist of up to 24 digits.

**Note:** If your public network requires waiting for a second dial tone, press \*.



**Press.**



**Press to finish programming.**

### Cancel one specific Individual Abbreviated Number

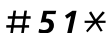

**Press.**



**Enter an Abbreviated Number between 0 and 9 and press.**

**Cancel all Individual Abbreviated Numbers**

**# 5 1 #**

**Press.**  
Confirmation tone.

## Dial-by-Name

You can program and activate directory numbers (extensions and Common Abbreviated Numbers) on the programmable keys.

Head Office 

**Press to make a call (pre-programmed).**

**Program Dial-by-Name**

How to program an internal directory number on a programmable key on the telephone and on the key panel.

PROG

**Press (see display).**

key

**Press (see display).**

— A 

**Press a programmable key.**  
The pre-programmed function will be shown in the display.

change

**Press (see display).**

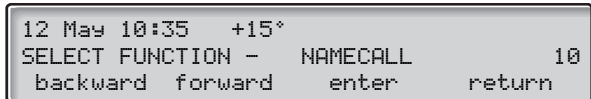

**Note:** If programmed names already exist, press backward or forward until the function NAMECALL is shown (see display).

enter 

**Press (see display) and dial the number.**  
You can use any directory number, e.g. a Common Abbreviated Number or a colleague's extension number.

store

**Press (see display).**



**Press to finish the procedure.**

# Phone Book

You can search for all directory numbers and Common Abbreviated Numbers in the integrated telephone directory.

directory

**Press (see display).**

The display shows:

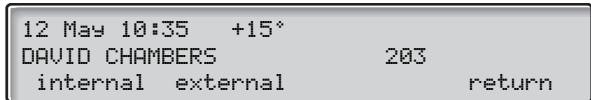

You can choose between *internal* telephone directory that contains all directory numbers, and *external* telephone directory that contains all Common Abbreviated Numbers.

internal

**Press (see display).**

To search in the internal telephone directory.

external

**Press (see display).**

To search in the external telephone directory.

You can press `search` (see display) to step through the whole directory or use the keypad to select the first or more characters of the second name.

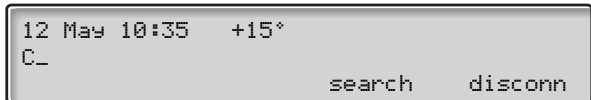

**Note:** How to write text is described in section [“Write Text”](#) on page 95.

search

**Press (see display).**

If the proposal is correct, call the number (see display). If not, use `backward` or `forward` to step through the directory.

## During Calls

The BusinessPhone Communication Platform allows you to handle calls in many different ways. You can switch between handset and handsfree/group conversation, mute the microphones, make an inquiry, transfer the call, create a Conference or put the call on hold to perform other tasks.

---

### Group Listening

You have an ongoing conversation via the handset.



**Press to switch the loudspeaker on or off.**

When the lamp lights, the loudspeaker monitors the call.

**Note:** You can adjust the volume, see section "[Settings](#)" on page 96.

---

### From handset to handsfree

You have an ongoing conversation via the handset.



**Press to switch the loudspeaker on.**

You are now in the Group Listening mode.



**Replace the handset.**

Handsfree conversation.

**Note:** You can adjust the volume, see section "[Settings](#)" on page 96.



**Press to end the call.**

## From handsfree to handset

You have an ongoing handsfree conversation.



### Lift the handset.

Conversation via the handset.

---

## Mute

You have an ongoing conversation.



### Press to switch the microphone on or off.

When the lamp lights, the caller will not be able to hear the conversation in your room.

---

## Inquiry

During an ongoing conversation you wish to make an inquiry to an internal or external party.

**Inquiry** 

**Press.**

**Or:**

**Line 2** 

**Press Line 2.**

The first call is put on hold (the lamp flashes slowly).



**Call the third party.**

When the third party answers you can switch between the calls, create a Conference and end one of the calls.



**Press to end the Inquiry call.**

The second call is disconnected.

**Line 1** 

**Press to retake the first call.**

You are now connected to the first party.

## Refer Back

You have an ongoing conversation on e.g. Line 2 and want to refer back to the call that is put on hold on Line 1. The lamp of the call put on hold flashes.

**Line 1** 

**Press to put the second call on hold.**

First call is connected.

**Inquiry or  
Line 2**



**Press to put the first call on hold.**

Second call is connected.



**Press to end the ongoing call.**

## Transfer

You have an ongoing internal or external conversation and you want to transfer the ongoing call.

**Inquiry or  
Line 2**



**Press.**



**Call the third party.**

You can transfer the call before answer or wait for answer.

**Note:** *Make sure, that you are connected to the desired party. Please read the notes and warnings in section “Useful Hints” on page 111.*

transfer

**Press (see display).**

**Or:**



**Replace the handset.**

The call is transferred. External calls might only be transferred with the Transfer key, if this state of connection is allowed by the system programming.

### Transfer to a busy extension

You can even transfer calls to busy extensions. The other party will hear a muted signal (Camp-on), and the call will be extended, as soon as the ongoing call is terminated (if Camp-on is allowed).

### **Callback**

You are called back, if you have transferred an external call and the other extension has not answered the call within a certain time. Your telephone will ring again.

---

## **Call Waiting**

If you hear the Call Waiting tone during an ongoing conversation, another person is trying to contact you.

### **To terminate the ongoing call and answer the waiting call**



**Replace the handset to finish the ongoing call.**

The waiting call is signalled on your phone.



**Lift the handset to answer the new call.**

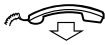

**Or:**

**Press and replace the handset to answer in handsfree mode.**

---

## **Conference**

You have an ongoing conversation and you want to establish a telephone conference.

***Inquiry or  
Line 2***



**Press.**



**Call the third party.**

**conf**

**Press to establish a three party conference (see display).**

Now you have established a three party conference. To indicate the Conference, all conference members will hear a periodical Conference tone.

**Repeat the procedure to include other persons into the Conference.**

In this way, you can include up to six parties in a conversation. How many of them can be external callers depends on the programming of the system.

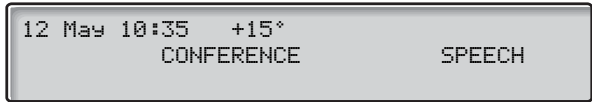

## Individual Hold

You have an ongoing conversation, i.e. the Line 1 key is lit. Now you want to put the ongoing call on hold for a short while.



**Press the Line key.**  
The lamp flashes slowly.



**Press again to retake the call that has been put on hold.**

## Common Hold



**Press (pre-programmed).**  
The Line key lamp flashes slowly. The call can be picked up on any extension within one minute, if not it will recall on the holding extension.



**Press to pick-up on own extension.**

**Or:**

Pick-up on another extension:



**Call the extension that put the call on hold.**

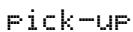

**Press (see display).**

# Call Metering

When the BusinessPhone Communication Platform is provided with metering information from the public net, the call metering function can be used to check the cost of outgoing calls. The BusinessPhone Communication Platform offers several options to obtain this information.

---

## Cost Indication

During an outgoing external conversation the display shows the actual cost. If you want to deactivate the Cost Indication you have two options:

### To deactivate the indication of the ongoing call:

cost-off

#### **Press (see display).**

To toggle between cost indication or no cost indication. The system will only show the call duration in case of an incoming external call or if the public net does not provide the system with metering information.

### To deactivate the indication for all further calls:

\*41#



#### **Dial.**

Verification tone, the Cost Indication is deactivated.

#### **Press.**

To activate the Cost Indication again for all further calls, repeat the procedure.

## Cost of the last call

After finishing an outgoing external call, you have the possibility to see the cost of the last call.

✖ 46 #



### Dial.

The display shows the cost of the last call.

**Press to finish the procedure.**

---

## Read out your own cost counter

This is useful, when you want to check the accumulated cost of your own counter.

✖ 45 #



### Dial.

The system shows the accumulated cost since the last reset.

**Press to finish the procedure.**

---

## Read out cost counter for others

If you have the authority, you can read out and reset the cost counters for other extensions and trunk lines. If your system is equipped with a printer you can initiate a printout.

✖ 45 #

### Dial.

The system shows the accumulated cost of your own extension since the last reset.

```

12 May 10:35   +15°
OWN COSTS:    50   EUR
other   check                               return
  
```

other



### Press (see display).

The system requires a Password.

### Enter the Password.

Ask your system administrator for the defined Password.



activate

**In case of a typing error, press the Volume Down key to delete the latest entered digit.**

**Press to confirm the Password (see display).**

Select the type of meter you want to read out.



caller

**Press to read out an extension counter (see display).**

If the system is included in a network, you will be able to read out the cost of the tie lines in this menu.

**Or:**

trunk

**Press to read out a trunk line counter (see display).**

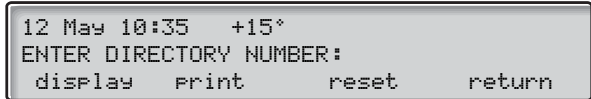

**Enter the directory number of the desired extension or trunk line.**

(If you do not enter a directory number the accumulated cost of the entire system will be shown.)

return

**Press to return to previous menu (see display).**

reset

**Press to reset counter (see display).**

**Note:** *The reset function in this menu is only applicable when a printer is connected to the system. To initiate a reset procedure you require a special authority level (please ask your system administrator if this feature is available on your phone). To avoid different countervalues for total extensions and total trunk lines in the system, we recommend to reset all the extensions and trunk line counters at the same time.*

print

**Press to initiate a printout on the printer (see display).**

This function is applicable when a printer is connected to the system.

You also require a special authority level to initiate a printout. For a detailed description of the printout, see section "Printout" on page 42.

display

**Press to show the counter on the display (see display).**

```

12 May 10:35  +15°
COST 201: EUR           50
      print         reset       return

```

In this menu you have the same possibilities as in the previous menu. It is also possible to reset without a printer.

If you have not entered a specific directory number in this procedure, you will see the accumulated cost of the entire system.

```

12 May 10:35  +15°
200-280: EUR           380
      detail                          return

```

detail

**Press to read out the detailed counters of each extension/trunk line (see display).**

In this menu you have the same possibilities as in the previous menu for reading out a single counter.

```

12 May 10:35  +15°
COST 200: EUR           20
      next      print         reset       return

```

next

**Press to step through all the counters (see display).****Press to finish the procedure.**

## Printout

The printout covers the following information:

*Example:*

*Call Metering Information BusinessPhone*

*Date: 03 05 12*

*Time: 10:53*

*ERICSSON ENTERPRISE GmbH*

*Pottendorfer Str. 25-27*

*1121 Vienna*

*AUSTRIA*

*Reason for print out : Read*

*Division : Total system*

*Group : Callers*

*Directory number range : 4736*

*Currency : EUR*

<u>Dir. No.</u>	<u>Name</u>	<u>Pulses</u>	<u>Cost</u>	<u>Cost/Pulse</u>
4736	Mr.Plattner	76	38.00	0.50
Total		76	38.00	

### Printout contents

<b>Date:</b>	Shows the date of the printout.
<b>Time:</b>	Shows the time of the printout.
<b>Ericsson Enterprise GmbH Pottendorfer Str. 25-27 1121 Vienna AUSTRIA</b>	4 lines with 50 characters per line are free for definition. For example, for the company address.
<b>Reason for printout:</b>	This field shows if the printout was initiated only to read out the counter or if the printout was caused because of a reset procedure.
<b>Division:</b>	This field is prepared for future applications. Currently it always shows <i>Total system</i> .
<b>Group:</b>	Shows if the desired directory number(s) is (are) related to the extension (caller) or trunk group.
<b>Directory number range:</b>	Shows the directory number of the desired extension or trunk line. When no directory number is entered then <b>ALL</b> will be shown in this field and you will see all the counters of the extensions and trunk lines on the display.
<b>Currency:</b>	Shows the defined currency.
<b>Dir.No.:</b>	Shows the directory number of the desired extension/trunk line.
<b>Name:</b>	Shows the name of the extension or trunk line.
<b>Pulses:</b>	Shows the accumulated pulses for the desired extension/trunk line since the last reset.
<b>Cost:</b>	Shows the accumulated cost for the desired extension/trunk line since the last reset.
<b>Cost/Pulse:</b>	Shows the actual price per pulse.
<b>Total:</b>	Shows the accumulated pulses and cost of all the extensions/trunk lines on the printout.

## Integrated System Check

To avoid a loss of the counter values during reconfigurations of the system, an Integrated System Check offers you the opportunity to read out all the counters which were not reset before the reconfiguration. To initiate the System Check you need a special authority level (please ask your system administrator if this feature is available on your phone).

**\*45#**

**Dial.**

(Same procedure as used for reading out accumulated cost.)

```

12 May 10:35 +15°
OWN COSTS:      20 EUR
other   check           return
    
```

check

**Press to initiate a System Check (see display).**

When a fault is found the following information will be shown:

```

12 May 10:35 +15°
CALLER RECORD FAULTY
display           return
    
```

display

**Press to display the fault records (see display).**

The display shows the first fault record in the system. The display information includes the extension numbers which have been deleted during the reconfiguration and the related cost for these extensions.

```

12 May 10:35 +15°
202 EUR 50.00 COSTS
next cost/pulse reset return
    
```

next

**Press to step through the faulty records (see display).**

cost/pulse

**Press to toggle between the indication in pulses or cost (see display).**

reset

**Press to reset the faulty record (see display).**

In this case no printout will be initiated to the connected printer.

return

**Press to return to previous menu (see display).**

# Call Forwarding

When you are not available to take calls or decide to answer your calls on another extension, it is useful to forward your calls to an alternate answering position.

If you urgently need to talk to someone who has forwarded his calls, the system is also equipped with a bypass function.

Depending on the type of diversion you are also able to record your personal greeting, see section “[Personal Greeting](#)” on page 57.

**Note:** *You can still make calls as usual.*

---

## Diversion when there is no answer

If you are not available to answer incoming calls (internal or external), your system administrator can program your extension to automatically divert calls to a programmed diversion address (default time: 15 seconds).

---

## Diversion when caller receives busy tone

If your extension is busy and you receive an incoming call (internal or external), your system administrator can program your extension to automatically divert the call to a programmed diversion address.

## Fixed Diversion

This function directs your calls to a pre-programmed answering position (e.g. secretary).

### Activate Fixed Diversion

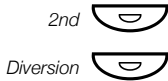

**Press.**

**Press to activate diversion.**

All calls to your extension are directed to a pre-programmed address. The display shows the actual diversion state.

```
12 May 10:35 +15*
DIVERSION 4736->5450
directory redial prog
```

### Cancel diversion



**Press.**

**Press to cancel diversion.**

## Program Fixed Diversion address

If you need to program a new diversion address:

PROG

**Press (see display).**

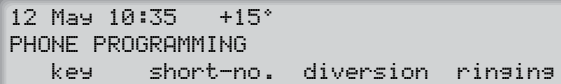

```

12 May 10:35 +15°
PHONE PROGRAMMING
key  short-no.  diversion  ringins
    
```

diversion

**Press (see display).**



**Dial new diversion address.**



**In case of a typing error, press the Volume Down key to delete the latest entered digit.**

store

**Press (see display).**



**Press to finish the procedure.**

## Individual Diversion

This feature gives you the possibility to divert your calls to internal and external positions, e.g. to any directory number, a colleague's extension, an external number or a Common Abbreviated Number (e.g. your car telephone).

**Note:** In order to prevent misuse, Individual External Diversion can be blocked for your extension, see section "Security" on page 71.

### Program and activate Internal Diversion

Divert your calls to an internal position.



**Press.**



**Press and dial the new directory number.**

Any directory number.



**Press.**

**Press.**

Verification tone. The Diversion lamp lights and remains lit. The display shows the actual Follow-me state.



**Press to finish the procedure.**

You can make outgoing calls as usual. A special dial tone reminds you that Call Forwarding is active.

**Note:** An Individual Internal Diversion cannot be activated if an Individual External Diversion is already activated.

### Cancel Internal Diversion



**Press.**

**Press.**

Individual Diversion is cancelled. The lamp extinguishes.

**Program and activate a new External Diversion address**

To set a new Individual External Diversion address:

**\* 2 2 \***

**Dial.**

**0** 

**Dial the digit(s) for external call access and enter the new External Diversion address.**

A maximum of 24 digits.

**Note:** *If your public network requires waiting for a second dial tone, press \*.*

**#**



**Press to activate the Individual Diversion.**

Verification tone.

**Press to finish the procedure.**

**Note:** *Before you leave, call your extension to check if the External Diversion has been set up correctly. This way you can make sure that the number has been programmed properly and that your calls will not be diverted to another person by mistake. Individual External Diversion can also be used via the DISA function, see section “Other Useful Features” on page 86.*

**Cancel External Diversion**

**# 2 2 #**

**Dial.**



**Press.**

**Note:** *The programmed diversion address is not removed from the memory, the diversion is just inactive.*

**Re-activate External Diversion**

Divert your calls to an external position.

**\* 2 2 \* #**

**Dial to activate the programmed External Diversion.**

You can make outgoing calls as usual. A special dial tone reminds you that Call Forwarding is active. The display shows that you have activated an External Diversion.



**Press.**

## Follow-me

If you are in another room, you can still answer your calls by forwarding them to where you are. To activate Follow-me, Individual Diversion must be active on your telephone.

### Activate Follow-me

**Note:** This procedure has to be executed from the telephone the calls are diverted to.

**\* 2 1 \***

**Dial.**



**Dial your number and press.**



**Dial the new number and press.**  
Special dial tone.



**Press to finish the procedure.**

### Cancel Follow-me

Follow-me and Individual Diversion can also be cancelled from the answering position.

**# 2 1 \***

**Dial.**



**Dial your number.**

**#**

**Press.**  
Dial tone.



**Press to finish the procedure.**

# Absence Information

If you are not in the office for a certain period of time (e.g. meeting, vacation, lunch, illness), this feature allows you to inform your callers of the reason of your absence. External callers will be routed to the operator who also has access to your Absence Information.

**Note:** *When you have activated a diversion with a Personal Greeting, callers will receive this greeting even if you have activated the Absence Information, see section “[Personal Greeting](#)” on page 57.*

You can inform your callers with:

## **1) Pre-defined texts**

Enter the reason for your absence and the date and time of your return.

## **2) Voice information**

Record a Voice message and name the reason of your absence.

## **3) Free text information**

Activate a personal text.

## Enter information

To store Text or Voice information.



leave

absence

**Press.**

**Press.**

**Press (see display).**

**Press (see display).**

When the information is activated, the Message/Info lamp shows a steady light. If a message arrives, the lamp starts flashing, see section [“Check and store received messages”](#) on page 61.

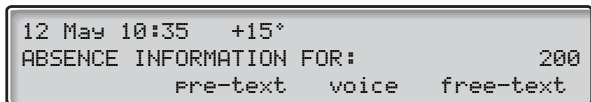

**Select pre-text, voice or free-text information.**

### Pre-defined texts

pre-text

next-info

**Press (see display).**

**Select appropriate info using next-info (see display).**



**Enter Completing Info from the table below.**

	Code	Completing Info
Time of return	1	hour (00-23) minute (00-59)
Date of return	2	month (01-12) day (01-31)
Lunch	3	back at, hour minute
Meeting	4	back at, hour minute
Vacation	5	back, month day
Illness	6	back, month day



**In case of a typing error, press Volume Down key to delete the latest entered digit.**

activate

**Press (see display).**

The programmed Absence Information will be shown in the display. Internal callers receive the information on the display (or as spoken information to callers without display phone). External callers will be routed to the operator who also has access to your Absence Information.

**Press to finish the procedure.**

*Pre-defined texts example:*

*Vacation, back June 27*

pre-text  
next-info**Press (see display).****Select appropriate info using next-info (see display).**

12 May 10:35	+15°		
5 VACATION	BACK		MMDD
activate next-info			return

**0627**

activate

**Enter month and day.****Press (see display).**

Information active.

**Voice information**

Use the menu keys to record your Voice info and activate it. Internal callers will hear the information via the handset or the loudspeaker. External callers will be routed to the operator who also has access to your Absence Information.

**Note:** *You can dial your own extension number if you want to check your information.*

**Press to finish the procedure.****Free text**

Use the keypad to select characters and digits, and the menu key to activate the information. Only available on display phones.

**Note:** *How to write text is described in section "Write Text" on page 95.*

**Press to finish the procedure.**

## Change information

2nd 

**Press.**

Info 

**Press.**

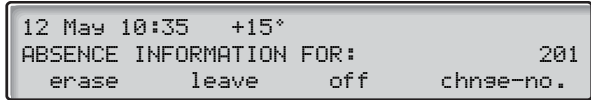

### Erase

erase

**Press (see display).**

absence

**Press to erase the information (see display).**

### Change

leave

**Press to leave another information (see display).**

**Or:**

on/off

**Press to activate/deactivate information (see display).**

### Leave information for another extension

chnse-no.

**Press (see display).**

This function may not be allowed, ask system administrator.

 activate

**Enter the extension number and press (see display).**

leave

**Press (see display).**

absence

**Press (see display).**

 activate

**Enter the information in the normal way and press (see display).**



**Press to store the information for the extension.**

## Receive info for diverted calls

A colleague, Andersen, has programmed diversion to your extension. You answer a call to Andersen on your phone. The sign '&' or '%' indicates that Andersen has Text or Voice info programmed.

### Text info programmed

ANDERSEN ANDREAS	200&
BURNES BOBBY	201 SPEECH
	div-info

div-info

**Press and hold to read Text info (see display).**

### Voice info programmed

ANDERSEN ANDREAS	200%
BURNES BOBBY	201 SPEECH
	div-info

div-info

**Press and hold to receive instructions on how to get the information (see display).**

# Messages

By using the Message system you can send, receive, forward and store different kind of messages. You have also access to a number of helpful features, like recording an ongoing conversation, placing external calls via the company network and many more ...

---

## Password protection

The first time you enter the Message system (only possible from your own extension) you might be requested to change your Password if it is default (0000).

**Note:** *Some systems are programmed to allow the Default Password.*

The following display is shown:

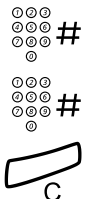
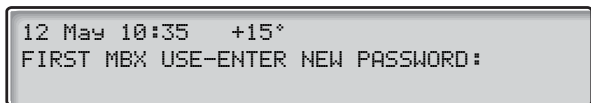

**Enter your new Password and press.**

If you use the Default Password, you are requested to try again.

**Enter your Password again and press.**

The new Password is saved.

**Press to finish the procedure.**

**Or:**

**Continue with any of the Message functions.**

If you want to change your Password again, see section "[Change Password](#)" on page 71.

## Individual Mailbox system

Callers are able to leave messages in your Individual Mailbox.

### Activate

Divert your extension to the Mailbox system.

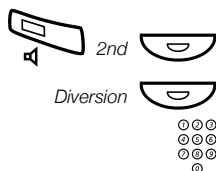

**Press.**

**Press.**

### **Dial the number to the Mailbox system.**

Ask the system administrator for your defined Mailbox system number.

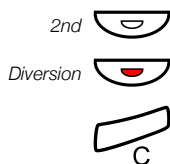

**Press.**

**Press.**

### **Press to finish the procedure.**

When the diversion to your Mailbox is activated, the Diversion lamp shows steady light.

### Deactivate



**Press.**

**Press.**

### Personal Greeting

Depending on the type of diversion you want to activate, you can leave three different Personal Greetings to the caller. You can activate a diversion when a caller receives busy tone, when there is no answer, or you can activate the Individual Diversion for all your calls.



**Press.**



**Press.**

leave

**Press (see display).**

greeting

Press (see display).

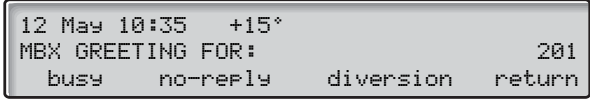

diversion

Select type of diversion and use the menu keys to record your greeting (see display).



Press to activate.

When you activate the diversion, the recorded greeting is played to the next caller.

*Note:* When you have activated a diversion with a Personal Greeting, callers will receive this greeting even if you have activated the Absence Information, see section "Absence Information" on page 51.

**Erase a greeting**



Press.



Press.

erase

Press (see display).

diversion

Select type of diversion (see display).



Press to finish the procedure.

**Retrieve messages - internally**

When a new message is received, the Message lamp flashes rapidly.



Press to retrieve a message.

See section "Check and store received messages" on page 61.

**Retrieve messages - externally**

To retrieve your messages from an external position:



Dial your company's telephone number.



### **Dial the number to the Mailbox system.**

During the procedure you will be asked for your extension number and your Password.

**Note:** *You cannot use the Default Password 0000 to retrieve messages externally. If you want to check your messages from an external position, you have to change your Password first, see section “[Change Password](#)” on page 71.*

The following Mailbox functions can also be used from an external position:

- Change Password
- Check and store received messages
- Forward a Voice message
- Send Message
- Outcall (External) Notification
- Personal Greeting

### **Outcall (External) Notification**

With this function the Message system can notify you when new Voice messages arrive. You can specify an external number, where you will be called at a pre-programmed time or as soon as a new message arrives.

**Note:** *This feature may be restricted or not available. Ask the system administrator for the availability and more information.*

You can be notified in two different ways (depending on the programming of the system):

#### *Notification with Mailbox access:*

You acknowledge the Notification via your Password (has to differ from the default value 0000). See section “[Change Password](#)” on page 71 to select a new Password. You have full access to the Mailbox system.

#### *Notification without Mailbox access:*

You get a short voice announcement, informing that someone has left a message for you. You acknowledge the Notification by pressing any key. You have to callback the Mailbox system to retrieve the message.

**Note:** If you do not acknowledge the Notification within the pre-programmed time, the connection is cancelled and repeated later (ask the system administrator for the programmed number of Notification attempts).

**Program Notification number and time**

Message 

**Press to view the Mailbox.**

**Note:** Depending on the configuration, you might be asked for your Password.

administr

**Press (see display).**

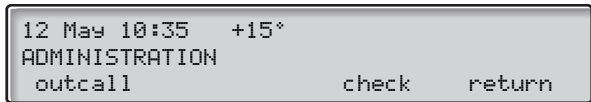

outcall

**Press (see display).**

number

**Press (see display).**

change

**Press (see display).**

0 

**Dial the digit(s) for external call access and dial the number.**

Which digit to press for external call access, depends on the configuration of the system. The external number (including the digit(s) for external call access) can consist of up to 24 digits.

save

**Press to save the number (see display).**

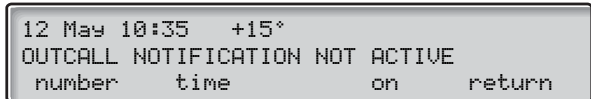

time

**Press (see display).**

change

**Press (see display).**



**Enter the Notification time.**

The time is entered in 24h format, e.g. 2030 for half past eight. Values are automatically set to even quarters, i.e. 2013 will be 2015.

immediate

save



**Or:**

**Press if you want immediate Notification (see display).**

**Press to save the Notification time (see display).**

This step is excluded if you program immediate Notification.

**Press to finish programming.**

**Activate/deactivate the Notification**

Message 

administr

outcall

on

off



**Press.**

**Press (see display).**

**Press (see display).**

**Press to activate (see display).**

**Or:**

**Press to deactivate (see display).**

**Note:** *The Notification number and time must be programmed before you activate the Notification.*

**Press to finish programming.**

**Check and store received messages**

You can check and store your received messages.

Received messages are divided into the following three categories:

- New messages (not heard or read)
- Heard/Read messages
- Stored messages

Voice messages can also be forwarded to other Mailbox numbers (Individual or Common), see section "[Forward a Voice message](#)" on page 63.

**Note:** *Messages are deleted from the system after a certain time. The time depends upon the category of the message. Please ask your system administrator regarding this.*

**Message** 

**Press to view the Mailbox.**

If the Mailbox contains heard messages only, the lamp shows steady light instead.

**Note:** Depending on the configuration, you might be asked for your Password before you can retrieve your messages. See section "Security" on page 71.

receive

**Press (see display).**

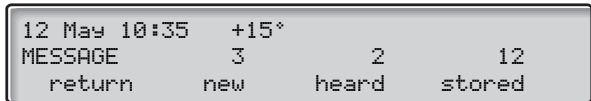

new

**Select message category (see display).**

New, heard, read or stored.

call-back

**Select message type (see display).**

**Note:** If only one message type is available (Callback, Voice or Text messages), this step is excluded. If an internal caller has left a message, the name and number is displayed. In case of an external caller, you can see the number, if this feature is provided by the network.

**Use the menu keys to check the message (see display).**

Voice messages will be heard via the speaker or the handset. Call Me messages will call the sender automatically. Text messages are read in the display.

Select one of the following options:

next

**Press to check the next message (see display).**

erase

**Press to erase the message (see display).**

store

**Press to store the message (see display).**

Up to 20 messages can be stored. Callback messages cannot be stored.



**Press to finish the procedure.**

### Forward a Voice message

Your received Voice messages (in the Individual or Common Mailbox) can be forwarded to other Mailbox numbers (Individual or Common). When you forward a Voice message to an Individual Mailbox, the Mailbox number is the same as the extension number. See also section “[Messages](#)” on page 56.

**Note:** *Returned messages cannot be forwarded.*

Message 

**Press to view the Mailbox.**

**Note:** *Depending on the configuration, you might be asked for your Password before you can retrieve your messages. See section “[Security](#)” on page 71.*

receive

**Press (see display).**

new

**Select message category (see display).**

New, heard or stored.

voice

**Press (see display).**

```

12 May 10:35 +15°
DAVID CHAMBERS          203
  play      next          erase  >>>
    
```

>>>

**Press (see display).**

forward

**Press (see display).**

```

12 May 10:35 +15°
FORWARD TO:
      forward                chnse-no.
    
```

○○○  
○○○  
○○○  
○

**Dial the Mailbox number to which you want to forward the message.**

forward

**Press (see display).**

The message is forwarded.

**Note:** *The forwarded message is a copy, i.e. it can be deleted without deleting the original message.*

**Repeat the procedure to forward the message to another Mailbox.**

**Press to finish the procedure.**



## Common Mailbox system

If you divert your telephone to a Common Mailbox, the callers are able to leave messages there. The difference between your Individual Mailbox and a Common one is that a Common Mailbox can be used by more than one user.

### Activate

Divert your extension to the Mailbox system.

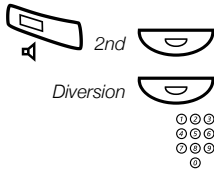

**Press.**

**Press.**

### **Dial the Common Mailbox number.**

Please ask the system administrator for your defined Mailbox number.

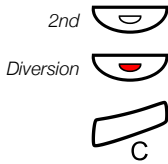

**Press.**

**Press.**

### **Press to finish the procedure.**

When the diversion to your Mailbox is activated, the Diversion lamp shows steady light.

### Deactivate



**Press.**

**Press.**

### Retrieve messages - internally



### **Press the Common Mailbox key (pre-programmed).**

During the procedure you will be asked for your extension number and your Password. See section “[Security](#)” on page 71.

**Retrieve messages - externally**

To retrieve your messages from an external position:



**Dial your company's telephone number.**



**Dial the Common Mailbox number.**

During the procedure you will be asked for your extension number and your Password.

**Note:** *You cannot use the Default Password 0000 to retrieve messages externally. If you want to check your messages from an external position, you have to change your Password first, see section "Change Password" on page 71.*

**Send Message**

You can send a message without calling an extension (direct message) or when you call an extension and receive busy tone or get no answer.

**Direct message**

**Message** 

**Press.**

send 

**Press (see display) and enter the extension number.**

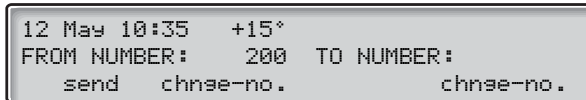

send

**Press (see display).**

call-back

**Select message type (see display).**

**Note:** *After sending, you can repeat to other extensions. You can also change the sending extension number, if you want the message to be sent from someone else (if this function is allowed). Please ask your system administrator if you require this function.*

**During an unanswered call**

When you call an extension and receive busy tone or get no answer, you can send a Callback, Voice or Text message.

**Message** 

**Press.**

```
12 May 10:35 +15°
FROM NUMBER: 200 TO NUMBER: 201
call-back voice text
```

**Select message type (see display).**

*Note: After sending, you can repeat to other extensions.*

**Callback**

call-back

**Press to send a Call Me message (see display).**

**Voice**

voice

**Press to send a Voice message (see display).**

**Use the menu keys to record and send your message (see display).**

**Text**

text

**Press to send a Text message (see display).**

Text messages only can be sent to display phones. See section [“Write Text”](#) on page 95.

## Check sent messages

You can check messages that you have sent, for instance if you want to erase a message. You can also check messages received at other extensions (not allowed by default, ask system administrator).

**Message** 

administr

check

**Press.**

**Press (see display).**

**Press (see display).**

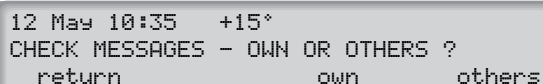

```

12 May 10:35 +15°
CHECK MESSAGES - OWN OR OTHERS ?
return          own          others
  
```

### Own messages

OWN

**Press to check your own messages (see display).**

Enter the receiving extension number. You can check and erase the messages that you have sent (see display).

### Others

others

**Press to check messages for another extension (see display).**

Enter the receiving number that you want to check. All messages will be presented with senders name. You can check and erase the messages (see display).



**Press to finish the procedure.**

## Returned messages

Messages that have been left unanswered for a long period are sent back to you. To check returned messages:

**Message** 

**Press.**



sent-back

**Press (see display).**

**Use the menu keys to check returned messages (see display).**

You can erase or re-send the message.



**Press to finish the procedure.**

## Dictaphone function

If you want to record and retrieve personal Voice messages you can use the Dictaphone function. A Dictaphone message is treated as a normal message. How to retrieve Dictaphone messages, see section “[Check and store received messages](#)” on page 61.

### Record message

To start the recording:

**\* 5 8 #**

#### **Dial and record your message.**

The maximum recording time is 4 minutes and 15 seconds.

```

12 May 10:35  +15°
RECORDING
record play-back pause activate
  
```

Select one of the following options:

- |           |  |
|-----------|--|
| PAUSE     | <b>Press to pause the recording (see display).</b>                     |
| play-back | <b>Press to play-back (see display).</b>                               |
| record    | <b>Press and speak to re-record (see display).</b>                     |
| activate  | <b>Press to stop the recording and save the message (see display).</b> |

## Conversation Recording

The Conversation Recording function makes it possible to store the ongoing telephone conversation in the Individual Mailbox by pressing a pre-programmed Recording key. You can store both internal and external calls. Conference calls cannot be stored.

A recorded conversation is treated as a normal Voice message. How to retrieve Conversation Recordings, see section [“Check and store received messages”](#) on page 61.

**Note:** *This feature may be restricted or not available. Ask the system administrator for the availability and for more information. Furthermore, a Conference tone can be audible during the entire recording session.*

To start or stop recording the ongoing call:

Recording 

### **Press the Recording key (pre-programmed).**

While recording is active a steady light indicates that the conversation is being recorded. You can start or stop the recording whenever you want. The maximum recording time is 4 minutes and 15 seconds, if you want to record for a longer period, just repeat the procedure.

**Warning!** *Recording a conversation without prior notice to the other party may be illegal. Forwarding or playback of this recorded conversation to a third party without prior permission may be illegal.*

*It is obligatory for the recording initiator, to ask the other party in advance for permission and to inform the same of the purpose and further usage of this particular recording. The adherence to the relevant legislation is the exclusive responsibility of the user, offences can be criminally prosecuted. Neither the manufacturer nor the dealer of this product is responsible for the abuse of this feature by the user or for any damages caused thereby.*

# Security

You can use your four-digit Password for blocking your phone from unauthorized use, for making external calls from any blocked extension, for entering the Message system or when you are using the DISA function.

**Note:** *The first time you enter the Message system you might be requested to change your Password if it is default (0000). This procedure is performed directly in the Message system. See section “Messages” on page 56.*

## Change Password

**# \* 7 2 \***

**Dial to select a new Password.**

⊙⊙⊙  
⊙⊙⊙  
⊙⊙⊙  
⊙

**Dial your present Password.**

The Default Password is 0000.

**\***

**Press.**

⊙⊙⊙  
⊙⊙⊙  
⊙⊙⊙  
⊙

**Dial your new Password.**

**#**

**Press.**

Verification tone.

```
12 May 10:35 +15°
#*72*----*4321#
```



**Press to finish the procedure.**

## Bypass blocked extension

In order to make a call, you can temporarily bypass a blocked extension.

### Bypass own extension

**\* 7 2 \***

**Dial.**

⓪⓪⓪  
⓪⓪⓪  
⓪⓪⓪  
⓪

**Dial your Password.**

**#**

**Press.**

Dial tone. You can make one call from your extension.

### Bypass another extension

This makes it possible to make a call on another, blocked extension, by using your Password.

**\* 7 2 \***

**Dial.**

⓪⓪⓪  
⓪⓪⓪  
⓪⓪⓪  
⓪

**Dial your Password.**

**\***

**Press.**

⓪⓪⓪  
⓪⓪⓪  
⓪⓪⓪  
⓪

**Dial your extension number.**

**#**

**Press.**

Dial tone. You can make one call from the blocked extension.

## Block extension

**\*72#**



**Dial to block your extension.**  
Verification tone.

**Press to finish the procedure.**

### Unblock extension

**#72\***



**Dial.**

**Dial your Password.**

**#**



**Press to re-open.**

Verification tone. Your extension is open for use.

**Press to finish the procedure.**

# Group Features

When you are working together in a team the following group features can be very useful. You can page your colleagues, give them Telephone Attendance or pick-up their incoming calls.

---

## Key system

With this function, all (or selected) external lines are represented by pre-programmed keys on all phones. For each external line, a Function key has to be programmed. Which means that you are able to monitor the state of traffic for every programmed external line (e.g. free, busy). You can also establish an external call by pressing the External Line key.

### Answer an external call

To answer an external call, just press the flashing key. (Depending on the programming of the system, an incoming external call will be announced with a flashing Line key and a ringing signal).

External Line



#### **Press (pre-programmed).**

Speech connection with the caller.

### Make an external call

To initiate an external call, just press the External Line key. The external line will be seized automatically.

External Line



#### **Press a free Line key (pre-programmed).**



#### **Dial the desired number.**

If you make external calls in this way, you do not have to dial the digit(s) for external call access first.

## Supervision/Telephone Attendance

A Function key can also be programmed for Supervision and handling calls for a group of extensions.

If a Supervision/Attendance key is programmed on your telephone, you are able to call the other group members or answer incoming calls for the group by pressing the key and monitor the activity of other extensions (free, busy, called).

### Traffic situation

Michael 

**Ongoing conversation (lamp is on).**

Michael 

**Free extension (lamp is off).**

Michael 

**The extension is called (flashing lamp).**

### Pick-up calls for the group

Your colleague's extension is indicated on your phone by a pre-programmed key.

Michael 

**Press to answer the calls directly (pre-programmed).**

A flashing lamp beside the key indicates an incoming call.

### Call a group member

Michael 

**Press to make a call (pre-programmed).**

**Note:** If the key is flashing, you will automatically pick-up your colleague's ongoing call.

---

## Group Call-pick-up

In a Pick-up group, any member can answer any individual call to group members. You answer a call to the group by dialling a special answering number. Please ask your system administrator for the configured number.



**Dial the Group Call-pick-up code.**

## Loudspeaker Paging

You can page all extensions in a group and give a Voice message.



**Press (pre-programmed).**

All extensions in a group are called.



**Press again and hold the key (pre-programmed).**

Give the Voice message and then release the key. Now you can wait for answer, or terminate. If you do not get an answer within 30 seconds, the Paging function will be terminated automatically.

### Answer Paging

A short signal and a flashing Paging key will inform you when a Loudspeaker Paging is received.



**Press (pre-programmed).**

An internal call is established with the paging party.

---

## Common Bell

The Common Bell feature allows all extensions of the system (operator included) to pick-up the call from an extension that has been predefined as a Common Bell extension.



**Dial the Common Bell pick-up code.**

Please ask your system administrator for the Common Bell pick-up code.

You will immediately be connected to the calling party. If two or more extensions simultaneously attempt to answer a call from the Common Bell extension, only the first extension will pick it up. The other extensions will receive the number unobtainable tone and their displays will show the message `NO CALL WAITING AT COMMON BELL`. This will also happen if you dial the Common Bell pick-up code and there are no calls waiting at the Common Bell extension.

**Note:** *You can also program the Common Bell code on a Function key.*

## Group Hunting

Your telephone can be included in one or several hunt groups. In a hunt group all members are represented with one common directory number. 16 hunt groups can be programmed, each containing 1 to 20 members. A member can be either an extension number, an operator console or a fictive number. Please ask your system administrator if you require this function.

**Note:** *The number of cordless extensions in a hunt group are limited to eight (including Tandem configurations).*

Incoming calls to the hunt group are directed to free extensions in the group. The hunt order within the group can be changed to suit your needs. If all members of the hunt group are busy, an incoming call is being queued. If no one answers this call before the programmed time, the call is forwarded to the programmed answering position (e.g. operator).

**Note:** *If all members in a hunt group are busy, the Callback or Intrusion function is not available.*

### Log in

Before you can answer Group Hunting calls, you must log in.

To log into one hunt group:

**\* 2 8 \***

**Dial.**



**Dial the hunt group code.**

Please ask your system administrator for the configured number.

**#**

**Press.**

To log into all hunt groups:

**\* 2 8 \***

**Dial.**

**\* #**

**Press.**

### Answer calls

As system default the hunt group number is shown in the display. If you require a different display layout, please contact your system administrator.

```
GH-GROUP          300
ANDERSEN ANDREAS  200  CALLING
directory         redial   Prog
```

**Answer Group Hunting calls in the normal way.**

### Log out

To log out from one hunt group:

**# 2 8 \***

**Dial.**



**Dial the hunt group code.**

Please ask your system administrator for the configured number.

**#**

**Press.**

*Note: If you are logged into more than one hunt group and log out from one of them, the display will show the following text:*

```
12 May 10:35  +15°
LOGGED OUT FROM AT LEAST ONE PBX GROUP
directory         redial   Prog
```

To log out from all hunt groups:

**# 2 8 \***

**Dial.**

**\* #**

**Press.**

# ISDN Facilities

This chapter is only relevant when your system is connected to a digital trunk line (ISDN-trunk line). It provides a general view of all the (supplementary) services available from the public net which are supported by the system. The services from the public net differ from market to market. Please ask your system administrator which features are available.

---

## Number Identification

The main difference compared to the analog public net is the number identification between the connected parties.

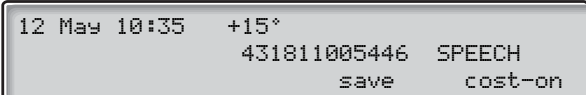

```
12 May 10:35 +15°
                431811005446 SPEECH
                    save cost-on
```

When you establish an outgoing external call, the public number of your system and your extension number will be sent to the called party. If the number of the answering party is different from the dialled one (for example, after a diversion), you will also be informed about the answering party's number.

When you answer an incoming external call on your phone (or from another phone), you will see the caller's number on the display. Your public number will be sent to the caller.

## Answer an incoming call from an ISDN-line

A ringing signal and a flashing lamp indicate an incoming call, answer the call in the normal way. One of the following four cases will occur.

### Example 1:

The public net provides the number of the caller.

Mr. Plattner with public number 0 181100 4736 is calling.

```

12 May 10:35  +15°
                1811004736  CALLING
directory                redial  prog
  
```

### Example 2:

The caller has activated Number Secrecy. (The calling number will be suppressed.)

```

12 May 10:35  +15°
DISPLAY RESTRICTED                CALLING
directory                redial  prog
  
```

### Example 3:

The public net cannot provide the calling number, in this case the normal number of the external line will be shown.

```

12 May 10:35  +15°
EXTERNAL                701  CALLING
directory                redial  prog
  
```

### Example 4:

The calling number has been diverted in the public net, the calling and the diverting number will be shown.

```

                43181188
                1811004736  CALLING
directory                redial  prog
  
```

## Make an external call on an ISDN-line

Establish an external call in the normal way.

If the called party is also connected to a digital trunk line, your public number is shown on the called party's display.

If the connected party number differs from the dialled one (for example: Diversion or Pick-up from another extension), your display shows the new number.

### Example:

Called Party number 0 181100 Extension 4736

```

12 May 10:35  +15°
                01811004736  FREE
                save
  
```

The desired extension 4736 will be answered by extension 5446.

```

12 May 10:35  +15°
                01811005446  SPEECH
                save      cost-on
  
```

When the connected party has activated Number Secrecy (number suppression), your display shows the following information.

```

12 May 10:35  +15°
DISPLAY RESTRICTED                SPEECH
                save      cost-on
  
```

## Malicious Call Identification

If you are disturbed by malicious external incoming calls, you can request a number tracing from the network provider.

If you cannot see the number of the caller or connected party (because of an activated number suppression), you have the possibility to register the number in the public network during the call.

*Malicious Call Id.* 

**Press to register the connected number (pre-programmed).**

**Or:**

**\*39#**

**Dial to register the connected number.**

If the function is accepted in the public net, your display shows the following information.

```
12 May 10:35 +15* MCID ACCEPTED
DISPLAY RESTRICTED SPEECH
save cost-off
```

If you cannot identify the connected party, your display shows the following information.

```
12 May 10:35 +15* MCID REJECTED
DISPLAY RESTRICTED SPEECH
save cost-off
```

After 3 seconds the display will revert to the previous state.

## ISDN Caller List

This function insures that you will not miss any incoming calls, by storing unanswered ISDN calls on your telephone, e.g. if you do not answer or your telephone is busy.

Via your telephone you can:

- See the number of unanswered calls
- Call the stored numbers in the Caller List
- Scroll through the Caller List
- See the time and date of the arrived calls
- Erase calls from the list

The number of calls in the list are indicated on your display, e.g. 10 CALLS indicates that 10 calls are stored in the list.

```

12 May 10:35 +15°
ANDERSEN ANDREAS      200  10 CALLS
directory list        redial  Prog
  
```

### Retrieve calls

To see the first entry in the Caller List:

list

#### **Press (see display).**

The display shows the following information, e.g. CALL 1/10 indicates the first of the 10 stored calls in the list.

```

12 May 10:35 +15°
431811005446          CALL 1/10
call      next      time      erase
  
```

**Note:** If you do not react within 30 seconds the display reverts to idle state. If you want to leave the function before the time-out, press the Clear key.

next

#### **Press to scroll through the list (see display).**

call

#### **Press to call the selected number (see display).**

When the call is successful, the number is automatically removed from the Caller List. The system automatically adds the digit(s) for external call access.

**Note:** If digit(s) for external call access has not been defined for your Caller List, contact your system administrator.

**Show date, time and call attempts for the selected call**

When you are retrieving calls from your Caller List.

time

**Press to see the date and time for the selected call (see display).**

You will see when the call was received and how many times the same call came in.

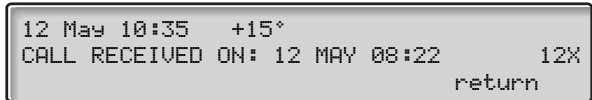

return

**Press to return to the previous display (see display).**

**Erase calls from the Caller List**

When you are retrieving calls from your Caller List.

erase

**Press to erase the selected call (see display).**

The call is erased from the list and the next call is displayed. The display will inform you if there are no more calls in the list.

**Note:** *If you do not react within 5 seconds the display reverts to idle state. If you want to leave the function before the time-out, press the Clear key.*

## Number Secrecy

By pressing a pre-programmed Number Secrecy key you can choose not to show your complete number (public + extension number) to the connected party.

```
12 May 10:35 +15*
DISPLAY RESTRICTED          SPEECH
                             save  cost-on
```

Number secrecy



**Press a pre-programmed key to suppress your complete number to the public net.**

The lamp beside the key shows a steady light and the function remains activated until the key is pressed again.

## Other Useful Features

By using these features your productivity will be increased, e.g. you can set reminders for important meetings, place the cost for external calls on separate accounts, listen to music via the loudspeaker and much more ...

---

### Tandem configuration

The Tandem configuration is a unit, consisting of two telephones using the same directory number. One of the telephones is defined as the *primary* and the other one as the *secondary*. This function enhances the communication for users that, for example, have a wired phone on their desk (the *primary telephone*) and need to be mobile within their company's building with their own portable (the *secondary telephone*). Basically the Tandem configuration works as follows:

#### To activate the Tandem configuration

Secondary on/off



**Press (pre-programmed).**

**Or:**

**\*28#**

**Dial to log on the secondary telephone.**

```
12 May 10:35 +15°
SECOND USER LOGGED ON
directory                redial        prog
```

For incoming calls:

- Both telephones are treated as 1 single extension.

For outgoing calls:

- Both telephones are treated as 2 separate extensions.

Secondary on/off



# 2 8 #

### To deactivate the Tandem configuration

**Press (pre-programmed).**

**Or:**

**Dial to log off the secondary telephone.**

For incoming calls:

- The *secondary* telephone cannot be called and the *primary* telephone works as a normal stand-alone telephone.

For outgoing calls:

- Both telephones are treated as 2 separate extensions.

Inquiry



Transfer



### Transferring a call between members of a Tandem unit

**Press and dial own directory number.**

**Press.**

## Reminder

The phone can be set to remind you at any time within the next 24 hours (multiple settings are allowed).

\* 3 2 \*



**Dial.**

**Dial Reminder time.**

(00-23) hour + (00-59) minute. Example: 1430.

12 May 10:35	+15*	
REMINDER TIME		1430
activate	clear	

**Note:** If you receive busy tone, your extension does not have the authority to set a Reminder.



**In case of a typing error, press the Volume Down key to delete the latest entered digit.**

activate



**Press to activate (see display).**

**Press to finish programming.**

When the Reminder time is reached, your phone rings with recall signal.

### Cancel Reminder

# 3 2 #



**Dial to cancel all settings.**

**Press to finish the procedure.**

---

## Background Music

You can listen to Background Music over the loudspeaker on your phone by pressing a pre-programmed Music key, or by entering the number for the music channel. Please ask your system administrator for the configured number.

*Background Music*



**Press to activate the music (pre-programmed).**

The music automatically switches off when you make or receive calls and switches on again when the call is finished.



**Press to cancel the music.**

**Note:** You can adjust the volume, see section "[Settings](#)" on page 96.

---

## Doorphone

The Doorphone is used to monitor the admission to your company, i.e you can open the doorlock from your phone.

### Answering Doorphone calls

**Line 1**

**Press the flashing Line key.**

You will be in speech connection with the calling party.

**Inquiry****Opening of the doorlock**

After you have answered the Doorphone, you can open the door making an inquiry to the door-opener's directory number.

**Press.****Dial the door-opener's directory number.**

Please ask your system administrator for the number.

**Note:** You can also program the door-opener's directory number as a Common Abbreviated Number or a Function key.

**Intercom Line**

A two-way direct call function between two extensions, for instance in executive-secretary communication.

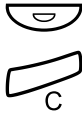
*Intercom secretary***Press to establish an Intercom call (pre-programmed).****Press to cancel the Intercom call.****Night Switching**

If you want this feature, please ask your system administrator. This function is used for directing all incoming calls to one extension (answering position), e.g. when the office is closed.

*Night***Press to activate or deactivate (pre-programmed).**

When the lamp lights, Night Switch is active. When the lights extinguishes, Night Switch is passive.

## Direct Inward System Access (DISA)

If you are working externally and you have the need to make business calls, call your company and use the company PBX to make an external call to the desired party. You just pay the cost for the phone call to your company. The other cost will automatically be placed on your extension number or on a special project.

**Note:** To activate this function, you have to change the Default Password from 0000 to a personal one. Which code to use and how to change it, see section [“Change Password”](#) on page 71.

You can also divert calls from your office extension to your external position, see section [“Call Forwarding”](#) on page 45. During the procedure you will be prompted for your Password.

⓪⓪⓪  
⓪⓪⓪  
⓪⓪⓪  
⓪

**Dial the public number of your company,**

⓪⓪⓪  
⓪⓪⓪  
⓪⓪⓪  
⓪

**followed by the DISA number.**

Ask the system administrator for the defined DISA number.

**Note:** If you want to register the call on an Account Number, you should use the Account Number procedure before you enter the external number, see section [“Account Number”](#) on page 91.

⓪⓪⓪  
⓪⓪⓪  
⓪⓪⓪  
⓪

**Dial the external number.**

**Or:**

**Use the External Diversion function.**

Procedure, see section [“Call Forwarding”](#) on page 45.

**Note:** If you program a new diversion address, remember to reset it when you return to your office.

## Account Number

An Account Number can be entered to debit telephone cost to different accounts. Depending on the system configuration the Account Number has to be entered from a Verified Account Number List (predefined) or you can invent your own Account Number. The following prerequisites apply:

- With the Verified Account Number you can restrict the making of external calls (not a specific number or area), so everyone who is allowed to make external calls will receive an Account Number which has to be used each time he/she wants to make an external call.
- Verified Account Numbers contain up to 10 digits and can only be used *before* you make a call (outgoing external calls).
- Own Account Numbers contain up to 15 digits and can be used *before* or *during* the call (outgoing external calls).

The Account Numbers can also be used via the DISA function, see section “[Direct Inward System Access \(DISA\)](#)” on page 90.

### Verified or own Account Number

✖ 9 ✖

#### **Dial.**

This code cannot be entered during the call.

#### **Or:**

#### **Press (pre-programmed).**

Account Number



#### **Enter Account Number and press.**

Valid digits 0-9.

## DTMF Tones

The DTMF function is used to control answering machines or any other telecommunication devices.



**Make an internal or external call to reach the desired device.** When your call is answered you can continue to dial digits which will be sent as DTMF digits (tone signals) to the called device in order to activate the desired functions.

---

## Immediate Answer

It is possible to get automatic hands-free answering on internal calls without pressing the Line key. If you require this facility, please ask your system administrator.

Immediate Answer



**Press the Immediate Answer key (pre-programmed).**

Incoming calls will be indicated by one muted ringing signal, the On/Off lamp lights and the call comes straight in through the loudspeaker.

**Note:** *To accept a transferred external call you must first press the Transfer key.*

### Cancel Immediate Answer

Immediate Answer



**Press the Immediate Answer key (pre-programmed).**

The lamp extinguishes.

## Networking

Networking is the connection of several premises within a company. The connection can be set up via leased lines, public lines, Local Area Network (LAN) or Wide Area Network (WAN). Ask your system administrator about details regarding networking.

---

## IP Calls

IP Calls are internal calls sent via an internal data network (LAN or WAN) and the transfer of data and voice is made on the same line. If you are connected to an internal data network the IP connection is made automatically. To minimize the traffic on the network the speech quality is decreased.

If the speech quality is not acceptable you can disconnect the IP Call and switch to a non-IP Call (alternative network). The switch from the IP net to the non-IP net is made during the call, so the call does not have to be disconnected.

If you want to switch to a non-IP net during the call:

**Inquiry**   
**\* 6 1 \***

**Press.**

**Dial.**

During the procedure the other party is put on hold. When the procedure is ready you will receive a special ringing tone and the call is resumed in the non-IP net.

```
12 May 10:35 +15°
SPEECH PATH REPLACEMENT
```

**Note:** A switch to a non-IP Call can only be performed if the original call is an IP Call, otherwise you will receive a Blocking tone.

## Least Cost Routing

Least Cost Routing (LCR) automatically selects the cheapest way to establish the connection to the desired external number. Please ask your system administrator if this function is installed in your system.

If the extension has been configured to use LCR, each external call will be analysed and the cheapest routing will be selected.

### Use Least Cost Routing

**0** 

**Dial the digit(s) for external call access and the external number.**

The usual way of making an outgoing external call.

### Calling Least Cost Routing

If LCR has been installed in your system, but your extension is not configured to use it automatically, you also have the opportunity to get the cheapest connection by dialling the LCR code before you dial an external number.



**Dial the LCR code.**

Please ask your system administrator for the LCR code.

**0** 

**Dial the digit(s) for external call access and the external number.**

*Note: You can also program the LCR code on a Function key.*

## Write Text

It is necessary to write text, e.g. when you are typing Absence Information, sending a Text message or searching the integrated telephone directory. Use the keypad to write text, e.g. when you are sending a Text message. You have selected text mode.



**Select characters by pressing digits repeatedly.**

*Example:*

**5**

**Press a digit**

1 time	result	J
2 times	result	K
3 times	result	L
4 times	result	5

**Note:** Key **1** is reserved for national characters.



**Press the Volume Up key to enter the character.**

Moves cursor to next position. Use also for space.

**Press the Volume Down key as backspace to erase incorrect entry.**

*Example:*

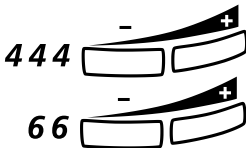

**Enter the first character code, followed by the Volume Up key.**

**This sequence - numbers always followed by the Volume Up key - gives the word IN\_ .**

**Note:** You can also write the following characters:  
? -, !: /# \*

**\***

**Press repeatedly.**

# Settings

If you require frequent use of certain functions, you may program them on the Dual-Function keys on the telephone and the key panel.

When you want to use the function, just press the key.

**Notes:** *The Dual-Function keys allow programmed functions and short numbers to be combined on the same keys.*



*Remove the transparent cover in order to write the name beside the key. Put the name referring to the programmed function in the field above the line to indicate that it is the primary function. If a function is already programmed on the key, this will be displayed when you start programming.*

*Programming of Dial-by-Name keys and Individual Abbreviated Numbers are described in section Abbreviated Numbers and how to program a new diversion address is described in section Call Forwarding.*

## Program a function

How to program a function on key A.

**Note:** Some functions can also be programmed as Individual Abbreviated Numbers, see section “[Abbreviated Numbers](#)” on page 27.

PROG	<b>Press (see display).</b>
key	<b>Press (see display).</b>
— A 	<b>Press the desired programmable key.</b>
change	<b>Press (see display).</b>
forward	<b>Select Function code (see display).</b> See section “ <a href="#">Function codes and required data</a> ” on page 99.
enter	<b>Press (see display).</b>
	<b>Enter associated number.</b> See section “ <a href="#">Function codes and required data</a> ” on page 99.
store	<b>Press (see display).</b>
	<b>Continue with section Select Ringing Character.</b>
	<b>Or:</b>
	<b>Press to finish programming.</b> After approximately 10 seconds, the Function key is active.



enter



PROG

key

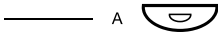

change

forward

enter

204

store

1

enter



Select ringing character

**Select ringing character (0 – 4).**

See section “[Function codes and required data](#)” on page 99.

**Press (see display).**

**Press to finish programming.**

After approximately 10 seconds, the Function key is active.

*Example:*

Program Supervision of extension 204 on key A, with ringing character 1. For available Function codes, see section “[Function codes and required data](#)” on page 99.

**Press (see display).**

**Press (see display).**

**Press the desired programmable key.**

**Press (see display).**

**Press until Supervision is shown (see display).**

**Press (see display).**

**Enter extension number.**

**Press (see display).**

**Press to select ringing character.**

**Press (see display).**

**Press to finish programming.**

## Function codes and required data

Programming name	Function name	Function code	Associated number	Ringing character
NAMECALL	Dial-by-Name	10	Extension number	—
SUFFIX DIGIT	Camp-on	11	4	—
	Automatic Callback	11	5	—
	Answer calls, another extension	11	6	—
	Radio Paging	11	7	—
	Intrusion	11	8	—
EXTERNAL LINE SUPERVISION	External Line	12	Directory number of line	0 – 4
	Supervision/ Telephone Attendance	13	Extension number	0 – 4
	Intercom Line	14	Extension number	0 – 4
DEDIC. LINE	Intercom Line	14	Extension number	0 – 4
BUSY LINE 2	Free On 2nd Access	26	—	—
CONFERENCE	Conference	27	—	—
IMMED. ANSWER	Immediate Answer	28	—	—
EXT. VOICE M.	External Voice Mail	34	—	—
HOLD	Hold	35	—	—
TRANSFER	Transfer	36	—	—
SAVE	Save/Redial	37	—	—
READ &	Read &	38	—	—
NUMB. SECRECY	Number Secrecy	40	—	—
ARD REQUEST	Automatic Redial	46	—	—
ARD PAUSE	Pause Automatic Redial	47	—	—

**Note:** Accessible functions depend on the programming of the system; if you require another function please contact your system administrator. The functions above are the default functions.

Ringing character:

0 = No ringing.

1 = Ringing.

2 = Delayed ringing (after 10 seconds).

3 = One single ringing signal (muted signal).

4 = One delayed ringing signal (after 10 seconds. Muted signal).

## Alternative programming for Automatic Callback, Camp-on, Intrusion

The associated number for using the Automatic Callback, Camp-on or the Intrusion function may vary from country to country. If you cannot use a code of a function, maybe your exchange system has been programmed with a different associated number.

Because this User Guide describes only the default programming, the following table shows the most common settings in some of these countries that are known for a different programming.

	<i>Austria, Belgium, Brazil, Denmark, Germany</i>
<i>Camp-on</i>	5
<i>Automatic Callback</i>	6
<i>Answer calls, another extension</i>	8
<i>Intrusion</i>	4

## Handset and loudspeaker volume

Use the volume keys. You can set different volume levels for internal and external calls and for Background Music. During a call, adjust handset listening volume in handset mode. Adjust loudspeaker volume in Monitor mode or during Background Music.



**Press to change the volume.**

## Ringing signal

By programming, you can adjust ringing type (2 types), ringing volume (10 steps) and ringing character (10 characters).

PROG

**Press (see display).**

```
12 May 10:35 +15°
PHONE PROGRAMMING
key short-no. diversion ringing
```

ringing

**Press (see display).**

You can now select ringing type, volume or character.

### Ringing type

Select type 1 if you want to set the ringing volume at a constant level, select type 2 if you want gradually increasing volume when the phone rings.

type

**Press (see display).**

You will hear the selected type.

next

**Press to change (see display).**



**Press to finish the procedure.**

**Note:** When type 2 is selected, the programming of the ringing volume is not applicable.

### Ringing volume

volume

**Press (see display).**

You will hear the selected volume (0...lowest volume, 9...highest).

lower

**Press lower or higher to change the level (see display).**



**Press to finish the procedure.**

**Note:** This programming is not applicable when you have selected ringing type 2.

character

next



### Ringling character

**Press (see display).**

You will hear the selected character.

**Press to change (see display).**

**Press to finish the procedure.**

---

## Melody programming

If you want a personal melody when your telephone rings, this can be programmed for internal, external or Callback calls.

**Note:** *This function requires a certain release number of your telephone (for the Dialog 4223 Professional/Dialog 3213 it is R9B or higher, see the underside of your telephone). If you can enter Melody Mode your telephone supports this function.*

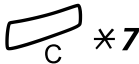

### Melody Mode

**Press and hold to enter Melody Mode.**





Melody Mode

**Enter Programming Mode to program a melody.**

**Or:**

**#**

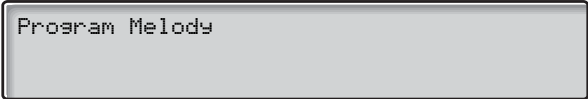
**Press to exit Melody Mode.**

2nd **Programming mode****Press to enter Programming mode.**

 Program Melody
**Select the call type you want to program.**Line 1 **Press for internal calls.****Or:**Line 2 **Press for external calls.****Or:**Inquiry **Press for Callback calls.****Select Programming mode options to control the melody.****Programming mode options***Insert notes:***Press to insert notes.**

1=c, 2=d, 3=e, 4=f, 5=g, 6=a, 7=b, 8+=c, 9+=d

**Note:** *Press and hold a key to make a long tone (shown with a capital letter e.g. D).**Change the pitch steps:*

#

**Press to change.**

Press once for sharp pitch, twice for flat pitch and three times to get the normal pitch.

*Insert a pause:*

**\*** **Press to insert a short pause.**  
Hold the key to get a long pause.

*Change the octave:*

**0** **Press to get a higher or lower octave for the note you have inserted.**  
It is higher when a plus sign is added beside the note.



*Scroll within the melody:*

**Press to move the cursor within the melody.**  
Hold the key to move to the beginning or the end.



*Erase note or melody:*

**Press to erase the note to the left of the cursor.**  
Press and hold to erase the whole melody.

*Store the melody:*

**Line or Inquiry**

**Press the flashing Line key.**

*2nd*

**Press to exit program mode.**

You enter Melody Mode.

**Line 1**

**Press to activate/deactivate the programmed melody for internal calls.**

**Or:**

**Line 2**

**Press to activate/deactivate the programmed melody for external calls.**

**Or:**

**Inquiry**

**Press to activate/deactivate the programmed melody for Callback calls.**

**#** **Press to exit Melody Mode.**

# Accessories

This chapter describes optional features that can be used together with your BusinessPhone telephone.

---

## Expansion key panel

### **Dialog 4223 Professional**

Each key panel offers 17 additional keys for storing of your most frequently used telephone numbers and functions, and for supervising extensions. Your telephone can be expanded with up to four key panels.

**Note:** *For the Dialog 4223 Professional, you need the optional key panel DBY 419 01.*

### **Dialog 3213 Executive**

Each key panel offers 17 additional keys for storing of your most frequently used telephone numbers and functions, and for supervising extensions. Your telephone can be expanded with up to four key panels.

**Note:** *If one or two key panels are used, the optional key panel DBY 409 01 may be used. However, if three or four key panels are used, all optional key panels must be of type DBY 409 02.*

## Alarm interface unit

**Note:** *Only available for the Dialog 3213.*

This plug-in module is fitted into the bottom of the telephone. It makes it possible to transfer alarm signals from various devices via the telephone to the exchange and to a pre-defined extension. A special circuit layout provides maximum functional security.

To a telephone fitted with an alarm interface unit you can connect devices such as bathroom alarms for hotel rooms, emergency alarms for hospitals, bank security alarms and supervision of machines.

---

## Option unit

### **Dialog 4223 Professional**

The Option unit DBY 420 02 is an optional accessory, to be installed on the bottom of your telephone set. The following devices can be installed via the Option unit:

- Tape recorder
- Extra bell or busy indication outside your door
- USB connector

### **Dialog 3213**

The Option unit DBY 410 02 is an optional accessory, to be installed on the bottom of your telephone set. The following devices can be installed via the Option unit:

- Tape recorder
- Extra bell or busy indication outside your door
- Enhanced Headset functionality
- PC Sound Card
- Second handset

**Note:** *For people with impaired hearing the Option unit offers the possibility to amplify the receiving volume in the handset and headset.*

## Extra handset

Useful for involving a second person in your conversation, for talking or just listening.

---

## Tape recorder

When a recording of the telephone conversation is needed, for evidence purposes, a tape recorder can be connected.

---

## Headset - Dialog 4223 Professional

How to install the headset, see section “[Installation](#)” on page 115. The following headset functions are available.



### Activate/Deactivate the headset

**Press the Headset key to activate/deactivate.**

See section “[Description](#)” on page 6. All calls can be handled via the headset.

### Answer calls

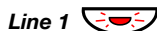

**Press the flashing Line key to answer.**



**Press to terminate a Headset call.**

### Make calls



**Dial the number.**



**Press to terminate the call.**



**Headset to handset**

**Lift the handset.**



**Handset to headset**

**Press the Headset key.**



**Headset with Group Listening**

**Press to toggle between headset with or without Group Listening.**



**Headset to handsfree**

**Press.**



**Press the Headset key.**



**Handsfree to headset**

**Press the Headset key.**

## Headset - Dialog 3213

The following Headset functions are available.

**Note:** To use the Headset functions your telephone has to be equipped with option unit DBY 410 02. How to install the option unit, see separate installation instructions provided with the option unit.

### Activate/Deactivate the headset



**Press the Headset key to activate/deactivate (optional).**

See section “[Description](#)” on page 6. All calls can be handled via the headset.

### Answer calls



**Press the flashing Line key to answer.**



**Press to terminate a Headset call.**

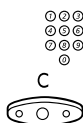

### Make calls

**Dial the number.**

**Press to terminate the call.**



### Headset to handset

**Lift the handset.**

### Handset to headset



**Press the Headset key (optional).**



**Headset with Group Listening**

**Press to toggle between headset with or without Group Listening.**



**Headset to handsfree**

**Press.**



**Press the Headset key (optional).**



**Handsfree to headset**

**Press the Headset key (optional).**

# Useful Hints

## Connections between external lines

With your BusinessPhone PBX, you can establish an external call diversion or a Conference with more than one external party or transfer an external call to another external destination (e.g. a mobile phone). These features are very useful for everyday business life.

**Note:** *When these features are used, your BusinessPhone will occupy at least two external lines.*

However, there may be disadvantages in connecting to several external lines. We would therefore like to draw your attention to the following:

- **Please do not transfer external calls to an external Mailbox, to information systems or to external parties before they have answered.**
- **Cancel your calls by pressing the Clear key.**

If the external parties are not persons (mailbox, automated information or attendant systems, etc.), connections on external lines can last a long time, which can be costly. Moreover, such calls may occupy two of your system's external lines. You can restrict connections between the external lines by re-programming your system.

Please ask your system administrator or contact our service center for more information.

# Glossary

## **Abbreviated Number Dialling**

Initiating a call to a pre-programmed number by dialling a code or pressing a key. Short numbers can be:

1. *Common, which means that all extensions can use them.*
2. *Individual, which means that they are programmed and used by each extension separately (82 numbers).*

See section "[Abbreviated Numbers](#)" on page 27.

## **Account Number**

To place call cost on an Account Number. See section "[Other Useful Features](#)" on page 86.

## **Automated Attendant**

A facility which sends voice instructions to internal and external callers, providing all options which can be chosen. Voice instructions lead the caller to the desired destination. See section "[Other Useful Features](#)" on page 86.

## **Callback**

An indication to a busy extension, to inform the person that you want to speak to him/her. See sections "[Messages](#)" on page 56 and "[Outgoing Calls](#)" on page 21.

## **Camp-on**

To place (queue) a call to a busy extension. See section "[Outgoing Calls](#)" on page 21.

## **Counter**

The counter keeps track of the time and cost of your calls. See section "[Call Metering](#)" on page 38.

## **Dial-by-Name**

Initiation of a call by operating a single key. Internal numbers (or Common Abbreviated Numbers) can be stored on each extension. See section "[Abbreviated Numbers](#)" on page 27.

## **Direct Inward System Access (DISA)**

If you are working externally, the DISA function enables you to make external calls (long distance) via the company PBX. You only pay for the call to your company. See section "[Other Useful Features](#)" on page 86.

## **Directory number**

Numbers with 1-8 digits which are assigned to extensions or external lines or as Common Abbreviated Numbers.

## **Diversion**

Incoming calls to an extension are diverted to another directory number (extension, Common Abbreviated Number or the operator). There are three possibilities:

1. *Direct, which means that all calls to an extension are forwarded directly.*
2. *On no reply, which means that a call is forwarded if it is not answered within a certain time.*
3. *On busy, which means that a call is forwarded if the extension is busy.*

See section "[Call Forwarding](#)" on page 45.

## **Diversion Bypass**

This is useful for letting urgent calls through to an extension where diversion is active. See section "[Call Forwarding](#)" on page 45.

**Extension**

All telephones connected to the PBX have a unique internal number (up to 8 digits). If your telephone is equipped with a display, you can see your number.

**Function code**

A digit code that corresponds to a specific function. See section [“Settings”](#) on page 96.

**Hold**

To put a call on hold. See section [“During Calls”](#) on page 33.

**Information**

Internal callers are informed about absence and time of return. External callers are diverted to the operator, where the same information is available. Information can be of three kinds:

1. *Pre-programmed text information.*
2. *Text information (only to display phones).*
3. *Voice information.*

**Intercom Line**

A two-way direct call function between two extensions, for instance an executive-secretary communication. See section [“Other Useful Features”](#) on page 86.

**Intrusion**

To intrude on an ongoing call when a requested extension is busy. See section [“Outgoing Calls”](#) on page 21.

**IP Call**

Internal call sent via an internal data network (LAN or WAN).

**ISDN**

Integrated Services Digital Network. Provides your system with supplementary services from the public net. See section [“ISDN Facilities”](#) on page 79.

**Least Cost Routing**

A function that automatically selects the cheapest way to connect your external call (not necessarily the shortest distance). See section [“Least Cost Routing”](#) on page 94.

**Loudspeaker Paging**

All members of an extension group are paged, i.e. receive a short, sharp tone on the loudspeaker followed by a Voice message from the sender. See section [“Group Features”](#) on page 74.

**Mailbox**

The Mailbox system controls the messages that are left for or sent by you when you are absent. See section [“Messages”](#) on page 56.

**Message**

A message can be sent to any extension. This is useful when you receive the busy tone or get no answer. There are three kinds of message:

1. *Call Me message.*
2. *Text message (only to a display phone).*
3. *Voice message.*

See section [“Messages”](#) on page 56.

**Metering**

Outgoing external calls can be metered on individual call meters or specified Account Numbers. See section [“Call Metering”](#) on page 38.

**Mute**

To switch the microphone temporarily off. See section [“During Calls”](#) on page 33.

**Night Switching**

Used for directing all incoming calls to one extension (answering position), for example when the office is closed. See section [“Other Useful Features”](#) on page 86.

**Password**

A four-digit code needed to e.g. block your extension and retrieve messages from the Mailbox system. You can set your own Password. See section [“Security”](#) on page 71.

**PBX**

Private Branch Exchange. Your telephone switching system (e.g. BusinessPhone 250).

**Pre-defined text**

Pre-programmed absence information. See section [“Absence Information”](#) on page 51.

**Third party**

A third connection (person), which can be included in an ongoing two person conversation.

The connection can be internal or external. See section “[During Calls](#)” on page 33.

**Tie line**

An external line from the private network.

**Transfer**

During an internal or external ongoing call you can make an inquiry and then transfer the call to another party (internal or external). See sections “[During Calls](#)” on page 33 and “[Useful Hints](#)” on page 111.

**Trunk line**

A trunk line is the same as an external line. Can be either digital or analog.

# Installation

## Dialog 4223 Professional

### Install cables

Handset cable to the left

Handset cable to the right

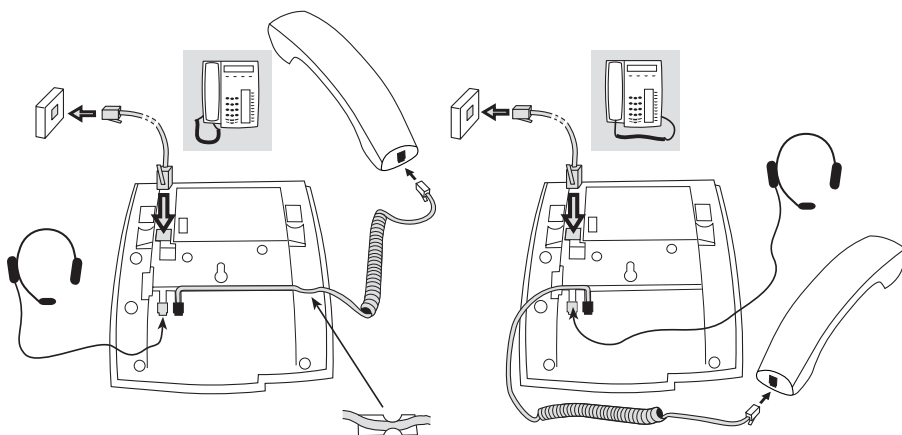

You can put the cable to the handset in the notch underneath the telephone. The cable to the exchange has to be plugged in LINE and the handset cable has to be plugged in HANDSET.

### Change cables

To remove a cable, use a screwdriver to unlock the stop.

## Install stands and adapt telephone

Position high

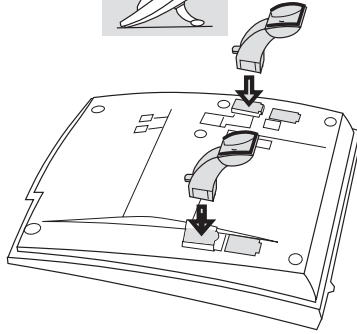

Position low

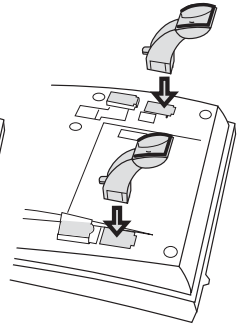

Press to fasten stand

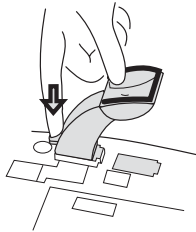

Release to remove stand

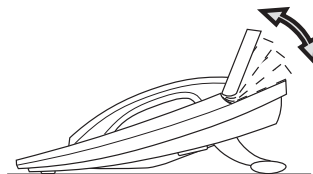
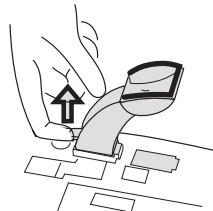

Tilttable display

Adjustable angle

## Install key panels

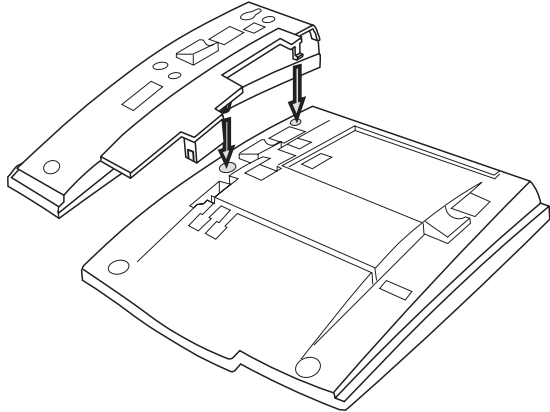

- 1 Remove the small plastic plate, marked DSS, i.e. with a screwdriver and connect the cable.**
- 2 Attach key panel unit.**
- 3 Secure with screws and install stand.**

**Note:** All key panels must be of type DBY 419 01 (three or four key panels can only be used in newer versions of the exchange).

**Stand positioning (1-4 key panels)**

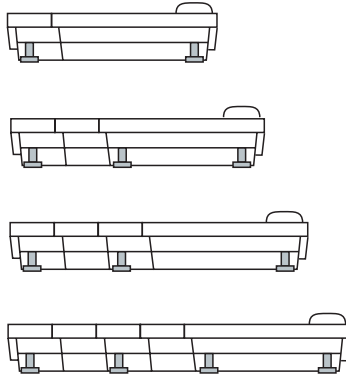

**Install card**

Use the Designation Card Manager to make and print your own key panel designation cards. The Designation Card Manager is included on the Ericsson Telephone Toolbox CD. For questions regarding the product, please contact your Ericsson Enterprise Certified Sales Partner.

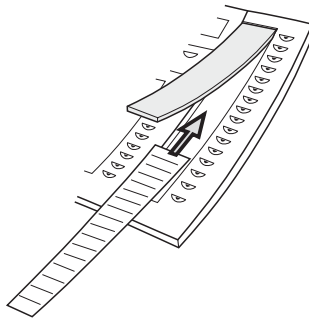

## Install pullout leaf

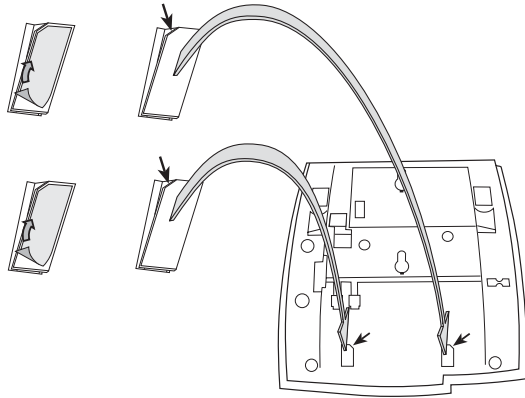

- 1 Remove the protective film from the guiding rails.**
- 2 Attach the guiding rails to the bottom of the phone, observing the direction of the “cut” corner.**

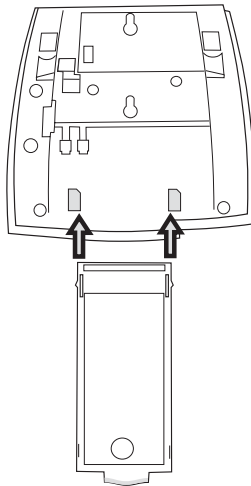

- 3 Insert the pullout leaf.**

## Wall mounting handset hook

The phone can be wall mounted without using a special console. Useful for instance in conference rooms or public areas.

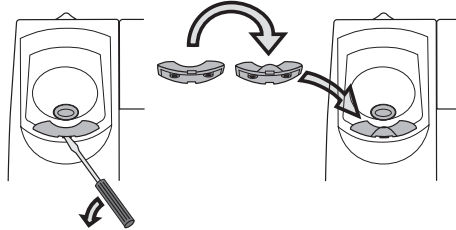

- 1 Use a screwdriver to remove the handset hook.**
- 2 Turn the hook upside down and insert.**

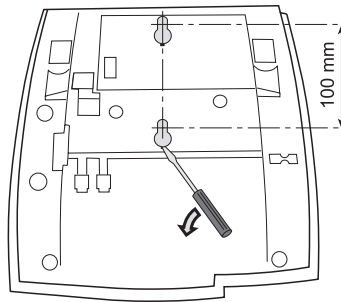

- 3 Use a screwdriver to remove the two plastic covers.**
- 4 Drill wall holes according to measure.**

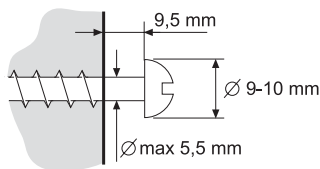

- 5 Mount screws according to measures and attach the phone.**

## Install card

Use the Designation Card Manager to make and print your own designation cards. The Designation Card Manager is included on the Ericsson Telephone Toolbox CD. For questions regarding the product, please contact your Ericsson Enterprise Certified Sales Partner.



---

## Placing the telephone

- Do not place your telephone on sensitive surfaces. Use a non-slippery pad to protect your furniture from possible damage.
- Do not place your telephone near sources of extreme heat, e.g. near the radiator.
- Make sure that the line cable isn't creased.

---

## Cleaning the telephone

Use a slightly moistened (not wet) soft cloth or an anti-static cloth and wipe off the telephone carefully. Do not use rough cloth, solvents or aggressive cleaning fluids. Any damages of the telephone, that are caused by non-observance of these instructions, are not part of the liability given by the manufacturer.

## Dialog 3213 Executive

### Install cables

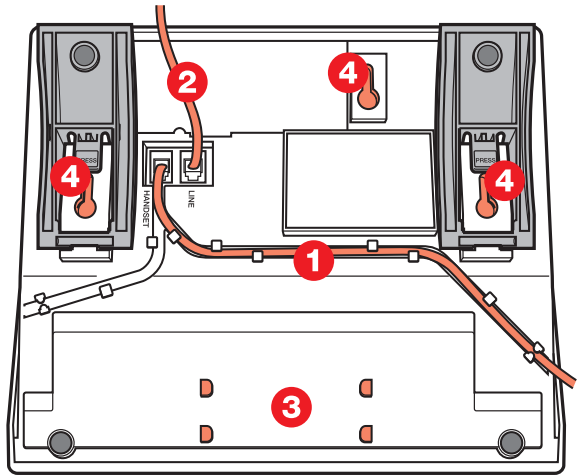

- 1 Cable to handset
- 2 Cable to exchange
- 3 Space for personal directory list (optional)
- 4 Wall mounting screw holes

You can put the cable to the handset in any of the two notches underneath the telephone. The cable to the exchange has to be plugged in LINE.

### Change cables

To remove a cable, push down the plug stop. Use a screwdriver to unlock the stop.

## Wall mounting handset hook

When mounting on a wall, you have to pull out and turn the hook.

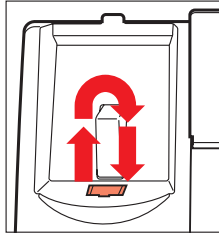

## Install stand and adjust telephone

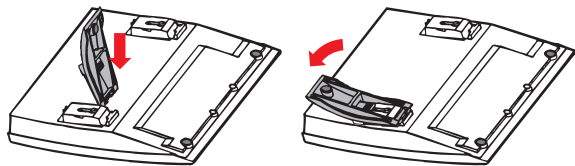

Press to decrease angle

Pull to increase angle

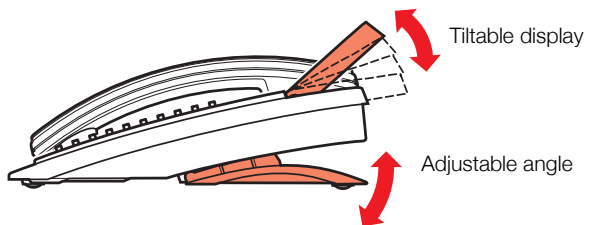
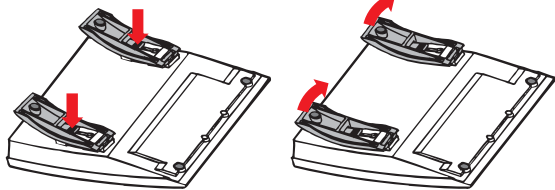

Tiltable display

Adjustable angle

## Install key panel

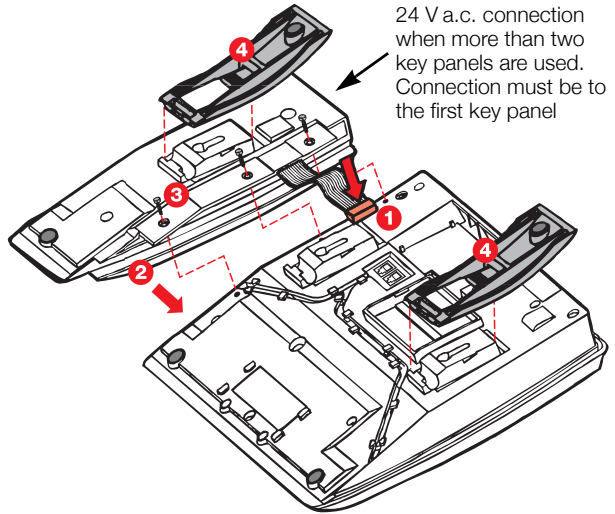

- 1 Connect cable
- 2 Attach key panel unit
- 3 Secure with screws
- 4 Install stand

When connecting one or two optional key panels to your telephone the DBY 409 01 key panel may be used. No external power cables are required for this key panel, as power is supplied from your telephone.

However, if three or four key panels are to be connected, then the DBY 409 02 optional key panel must be used for all key panels connected to your telephone. Whereby, a 24 V a.c. power cable must be attached to the first key panel connected to your telephone to provide power to all key panels.

## Placing the telephone

- Do not place your telephone on sensitive surfaces. Use a non-slippery pad to protect your furniture from possible damage.
  - Do not place your telephone near sources of extreme heat, e.g. near the radiator.
  - Make sure that the line cable isn't creased.
- 

## Cleaning the telephone

Use a slightly moistened (not wet) soft cloth or an anti-static cloth and wipe off the telephone carefully. Do not use rough cloth, solvents or aggressive cleaning fluids. Any damages of the telephone, that are caused by non-observance of these instructions, are not part of the liability given by the manufacturer.

# Index

## A

- Abbreviated Numbers 27
  - Common 28
  - Individual 29
- Absence Information 51
  - Change 54
  - Diversion 55
  - Enter 52
  - Erase 54
  - For another extension 54
  - Free text 53
  - Pre-defined 52
  - Voice 53
- Accessories 105
- Account Number 91
- Alarm interface unit 106
- Alternative programming for Automatic
- Callback, Camp-on, Intrusion 100
- Answer an incoming call from an ISDN-line 80
- Automatic Callback 23
- Automatic Redial 24

## B

- Background Music 88
- Block extension 73
- Busy extension 26
- Bypass blocked extension 72
- Bypass call forwarding 27

## C

- Call Forwarding 45
  - Diversion when caller receives busy tone 45
  - Diversion when there is no answer 45
  - Fixed Diversion 46
  - Follow-me 50
  - Individual Diversion 48
- Call Metering 38
  - Cost Indication 38
  - Cost of the last call 39

- Printout 42
- Read cost counters 39
- System Check 44
- Call Waiting 36
- Camp-on 26
- Change information 54
- Change Password 71
- Check and Store Received Messages 61
- Check sent messages 67
- Common Abbreviated Numbers 28
- Common Bell 76
- Common Hold 37
- Common Mailbox system 64
- Conference 36
- Conversation Recording 70
- Cost Indication 38
- Cost of the last call 39
- Counter 39

## D

- Description 6
  - Display info 14
  - Lamp indications 13
  - Signals 17
  - Tones 16
- Dial-by-Name 31
- Dictaphone 69
- Dictaphone function 69
- Direct Inward System Access (DISA) 90
- Display info 14
- Diversion when caller receives busy tone 45
- Diversion when there is no answer 45
- Diverted extension 27
- Doorlock 89
- Doorphone 88
- DTMF Tones 92
- During Calls 33
  - Call Waiting 36
  - Conference 36

- Handsfree 33
- Inquiry 34
- Loudspeaker 33
- Mute 34
- Park call 37
- Refer Back 35
- Transfer 35

**E**

- Enter information 52
- Expansion key panel 105
- External calls 18
- External Diversion 49
- Extra handset 107

**F**

- Fixed Diversion 46
- Follow-me 50
- Forward a Voice message 63
- Free text information 51
- Function codes and required data 99

**G**

- Glossary 112
- Group Call-pick-up 75
- Group Features 74
  - Common Bell 76
  - Hunt group 77
  - Key system 74
  - Page extensions 76
  - Pick-up group 75
  - Supervision 75
- Group Hunting 77
- Group Listening 33

**H**

- Handset and loudspeaker volume 100
- Handset to headset 109
- Handsfree to headset 110
- Headset 109
- Headset to handset 109
- Headset to handsfree 110
- Hold 37

**I**

- Immediate Answer 92
- Incoming Calls 18
  - Answer 18
  - Handsfree 18
  - Redial number 20

- Save number 20
- Second call 19
- Silent Ringing 20
- Individual Abbreviated Numbers via a programmable key 29
- Individual Abbreviated Numbers via the keypad 30
- Individual Diversion 48
- Individual Hold 37
- Individual Mailbox system 57
- Information
  - Erase 54
  - For another extension 54
  - Free text 53
  - Pre-defined 52
  - Voice 53
- Inquiry 34
- Installation Dialog 3213 122
  - Adjust 123
  - Cables 122
  - Cleaning 125
  - Key panel 124
  - Placing 125
  - Stand 123
  - Wall mounting 123
  - Wall mounting handset hook 123
- Installation Dialog 4223 115
  - Adapt 116
  - Cables 115
  - Card 121
  - Cleaning 121
  - Key panels 117
  - Placing 121
  - Pullout leaf 119
  - Stands 116
  - Wall mounting handset hook 120
- Integrated system check 44
- Integrated telephone directory 32
- Intercom Line 89
- Internal calls 18
- Internal Diversion 48
- Internal Messages 56
- Intrusion 26
- IP Calls 93
- ISDN Caller List 83
- ISDN Facilities 79
  - Answer call 80
  - Caller list 83
  - Make call 81
  - Malicious call 82
  - Malicious Call Identification 82

Number Identification 79  
Number Secrecy 85

**K**

Key panel 105  
Key system 74

**L**

Lamp indications 13  
Last External Number Redial 22  
Least Cost Routing 94  
Loudspeaker Paging 76

**M**

Mailbox system  
    Common 64  
    Individual 57  
Make an external call on an ISDN-line 81  
Make calls 21  
Malicious Call Identification 82  
Melody programming 102  
Messages 56  
    Callback 66  
    Check and Store Received 61  
    Check sent 67  
    Common Mailbox system 64  
    Conversation Recording 70  
    Dictaphone 69  
    Forward a Voice message 33  
    Individual Mailbox system 57  
    Outcall (External) Notification 59  
    Password protection 56  
    Personal Greeting 57  
    Record 69  
    Returned 68  
    Send 65  
    Text 66  
    Voice 66  
Music 88  
Mute 34

**N**

Networking 93  
Night Switching 89  
Number identification 79  
Number Secrecy 85

**O**

Option unit 106  
Other Useful Features 86

Account Number 91  
Background Music 88  
Direct Inward System Access (DISA) 90  
Immediate Answer 92  
Intercom Line 89  
IP Calls 93  
Least Cost Routing 94  
Networking 93  
Night Switching 89  
Reminder 87  
    Tandem configuration 86  
Outcall (External) Notification 59  
Outgoing Calls 21  
    Automatic Redial 24  
    Callback 23  
    Camp-on 26  
    Common Abbreviated Numbers 28  
    Dial-by-Name 31  
    Diverted extension 27  
    Handsfree 21  
    Individual Abbreviated Numbers via a programmable key 29  
    Individual Abbreviated Numbers via the keypad 30  
    Intrusion 26  
    Make 21  
    Redial number 22  
    Save number 22

**P**

Password 71  
Password protection 56  
Personal Greeting 57  
Phone Book  
    Directory 32  
Pre-defined texts 51  
Printout 42  
Program a function 97  
Program Fixed Diversion address 47

**R**

Read out cost counter for others 39  
Read out your own cost counter 39  
Receive info for diverted calls 55  
Redial number 22  
Refer Back 35  
Reminder 87  
Returned messages 68  
Ringin signal 101

**S**

Save and redial incoming calls 20  
Save external number 22  
Security 71  
Send Message 65  
Settings 96  
Short Numbers 27  
Signals 17  
Silent Ringing 20  
Supervision 75  
System Check 44

**T**

Tandem configuration 86  
Tape recorder 107  
Telephone Attendance 75  
Telephone directory 32

Tones 16  
Transfer 35  
Two telephones 86

**U**

Unblock extension 73  
Useful Hints 111

**V**

Voice information 51  
Volume 100

**W**

Welcome 4  
Write Text 95



# Quick Reference Guide

## Answer Calls

Answer on another extension: **Ext. No. Pick-up**

Save external number: **save**  
(Before you finish the call)

## Make Calls

Common Abbreviated Number: **Abbreviated No.**

Abbreviated Number:

Individual **2nd** 

Abbreviated Number: **Airport** 

Last External Number Redial: **\* \* \***

Save external number: **save**  
(Before you finish the call)

Redial: **redial**

## You get busy tone or no answer

Automatic Callback: **call-back**  
**Replace handset**  
*Lift handset when called back*

Camp-on: **camp-on**  
**Keep handset off hook**

Intrusion: **intrusion**

## During Calls



Switch to handsfree:  **Replace handset**

Switch to handset: **Lift handset**



Group Listening: 

Individual Hold: **Line 1**   
**Press flashing key to retake**



## Transfer

Transfer a call: **Inquiry**  or  
**Line 2**  **Call 3rd party transfer** or  
**Replace handset**  
(Before or after answer)



## Conference

Ongoing conversation: **Inquiry**  or  
**Line 2**  **Call 3rd party conf**

## Inquiry

Ongoing conversation: **Inquiry**  or  
**Line 2**  **Call 3rd party**

## Refer Back

Switch between calls: **Line 1**  or **Line 2**   
or **Inquiry** 



End call: 





## Messages



Direct message: **Message**  **send**  
**Ext. No. send**  
**call-back** **Select type**

Check received messages: **Message**  **receive**  
**Select options in display**

## Call Forwarding

Fixed Diversion: **2nd**  **Diversion** 

Internal Diversion:  **2nd**   
**Diversion**  **New No.**  
**2nd**  **Diversion** 

Cancel: **2nd**  **Diversion** 

Follow-me: **\* 2 1 \*** **Own No. \***  
**New No. #**

Cancel: **# 2 1 \*** **Own No. #**

Bypass Call Forwarding: **\* 6 0 \*** **Ext. No. #**

External Diversion:

Program: **\* 2 2 \***  
**Line access code**  
**External No. #**

Cancel: **# 2 2 #**

Re-activate: **\* 2 2 \* #**

Ericsson is shaping the future of Mobile and Broadband Internet communications through its continuous technology leadership. Providing innovative solutions in more than 140 countries, Ericsson is helping to create the most powerful communication companies in the world.

All rights reserved.  
Ericsson Enterprise AB  
For questions regarding the product,  
please contact your Ericsson Enterprise Certified Sales Partner.  
Also visit us on [www.ericsson.com/enterprise](http://www.ericsson.com/enterprise)

© Ericsson Enterprise AB 2003  
EN/LZTBS 160 1322 R1A

